













PART LIST

NO.	PART IMAGE	PART NAME	QTY
01		3-Way Connector	2
02		T-Connector	10
03		4-Way Connector	4
04		114 Degree Connector	2
05		156 Degree Connector	2
06		3.25" (83mm) Yellow Tubing	8
07		12.38" (314mm) Yellow Tubing	2
08		26" (660mm) Yellow Tubing	2
09		26.75" (679mm) Yellow Tubing	8
10		Release Pliers	1
11		Locking Castor Assembly	4
12		5 Clear Pocket	1
TOTAL.....			46



INSTRUCTION MANUAL

IMPORTANT:

Read through these simple instructions before starting assembly.

1. KEEP UNUSED PARTS IN THE MARKED BAG UNTIL USED.
Some parts are very similar and can be confused.
2. Assemble each section separately - as shown in the exploded drawings.
3. If parts need to be loosened, use our "release pliers" to loosen the connection
4. After each section is complete, assemble the sections together into the final unit.

ASSEMBLY & DISASSEMBLY

• How to Assemble & Disassemble Tube and Connector

Note: Do not hold tube and connectors where you insert each piece as finger may be pinched.

(1) Slip the tube through loops in vinyl.

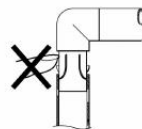

Fig. 1



Fig. 2

(2) Push the connector into tube and turn the tube until a "click" is heard.

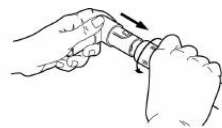

Fig. 3

(3) Put release pliers into holes that have safety lock pins coming through and squeeze the pliers to release the tube from the connector.

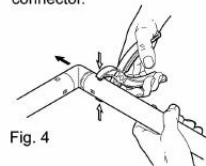

Fig. 4

(4) Finish the assembly of both connectors with the tube in between. Then insert the connectors into two separate tubes to complete a panel. (Fig. 5-1)
Do not assemble the tubes and connectors one by one. (Fig. 5-2)

OK (EASY)

NG (HARD)



Fig. 5-1



Fig. 5-2

ASSEMBLY ILLUSTRATION

#905-052A 5 POCKET DISPLAY W/ CASTORS

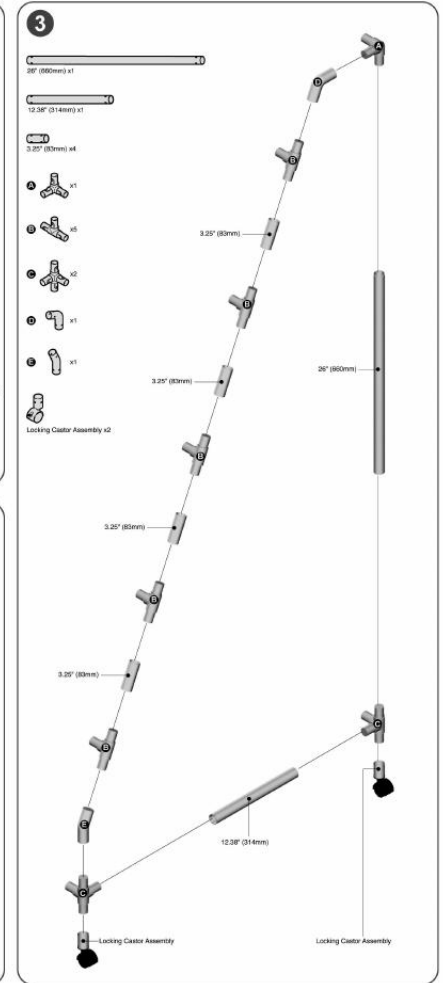
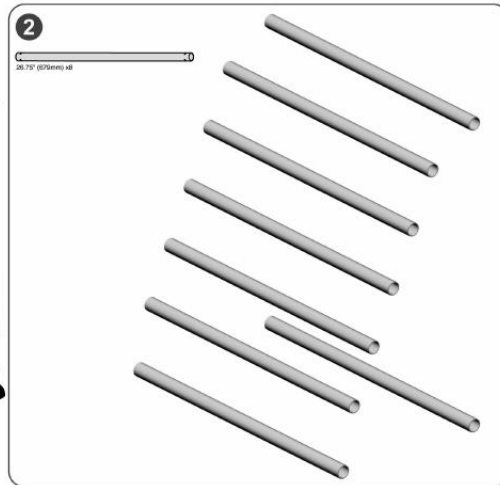
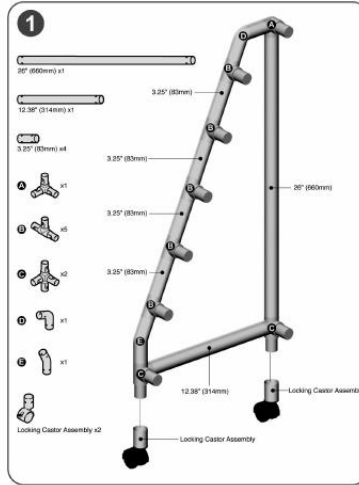

1 **2** **3**