

咻咻的尋寶旅程

Shushu's Journey of Searching Treasure



JUNIOR ENGINEER

7267

97 PCS

幸福遊樂園 THEME PARK



3+



20 MODELS TO BUILD

LET'S PLAY BLOCKS WITH AWESOME STORYBOOKS

目錄	Index		p1	
零件表	Part List		p2	
模型	Model 1	碰碰車	Bumper Car	p3
模型	Model 2	遊園纜車	Tram	p7
模型	Model 3	滑水道1	Waterslide 1	p9
模型	Model 4	滑水道2	Waterslide 2	p11
模型	Model 5	旋轉木馬	Merry-go-round	p13
模型	Model 6	海盜船	Pirate Ship	p17
模型	Model 7	蹺蹺板	See-saw	p21
模型	Model 8	皇宮劇場	Palace Theater	p24
模型	Model 9	雲霄飛車	Roller Coaster	p27
模型	Model 10	摩天輪	Ferris Wheel	p31
十款軌道組合		10 Tracks		p34

零件表 | PART LIST

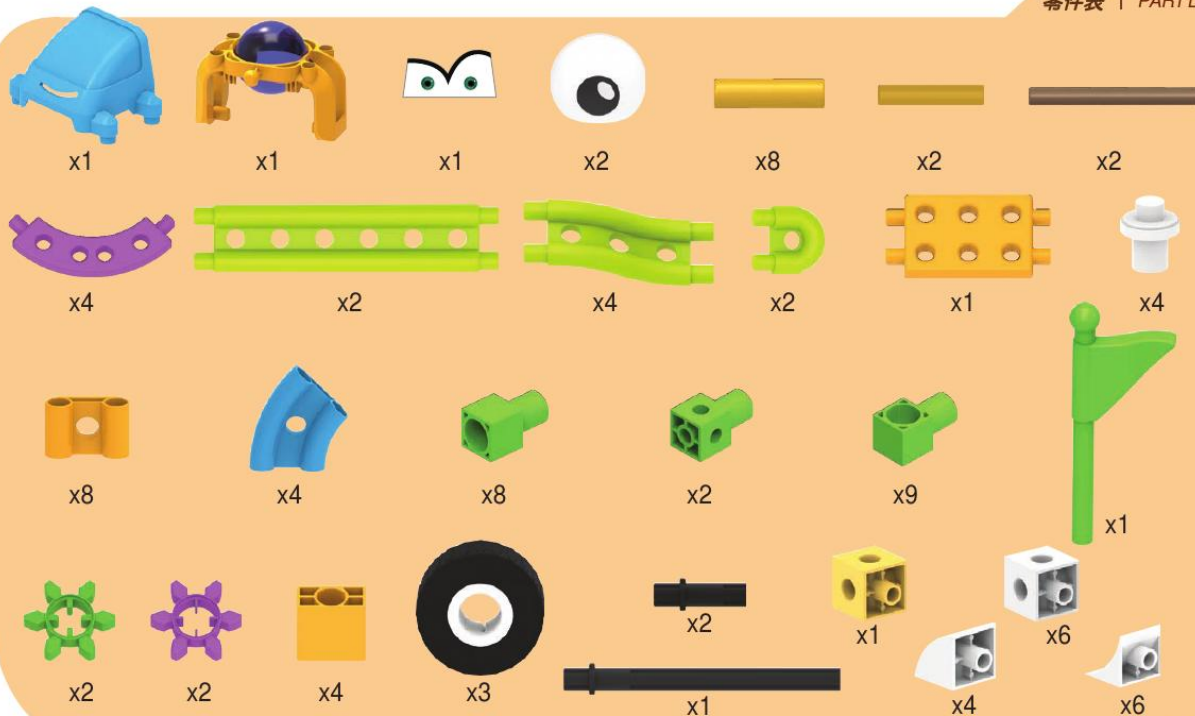

角色 Character

邦妮

總是急急忙忙的，
沒有耐性，個性橫衝直撞

Bonnie

Always in a hurry,
no patience, personality
rampage.

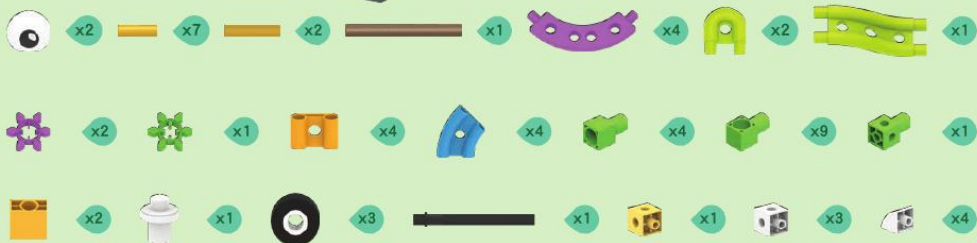

1 碰碰車 Bumper Car

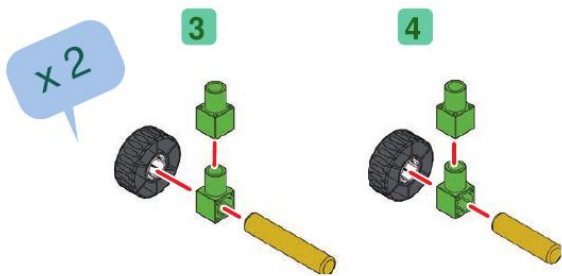
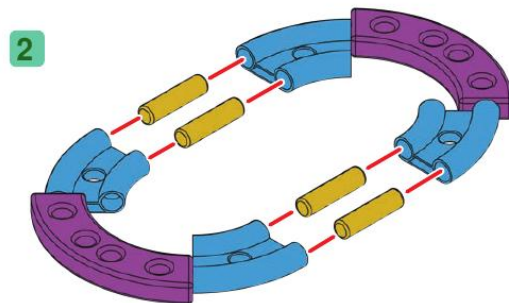
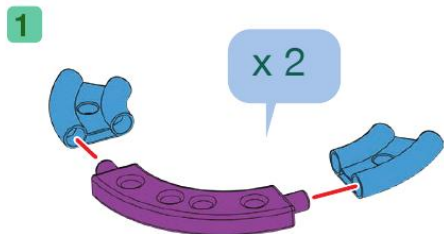

5

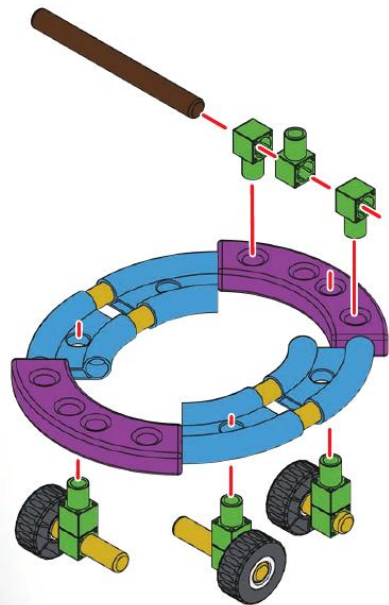

6

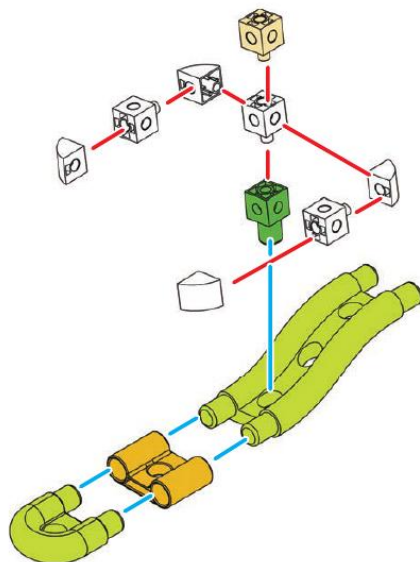

7

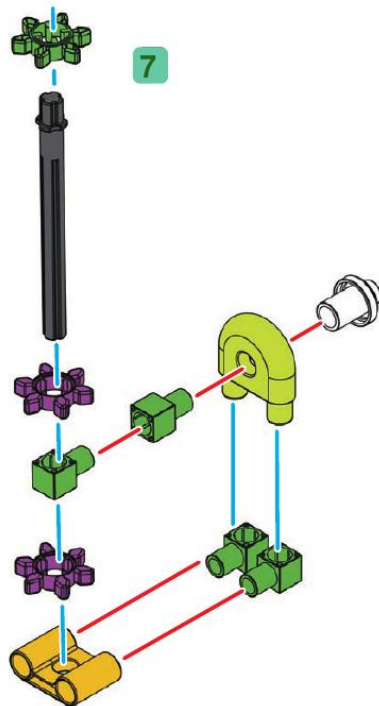

1 碰碰車 Bumper Car

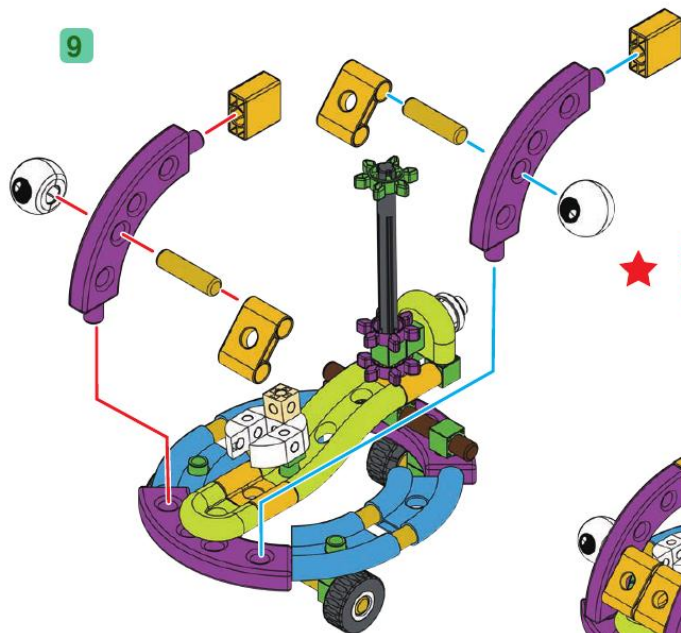
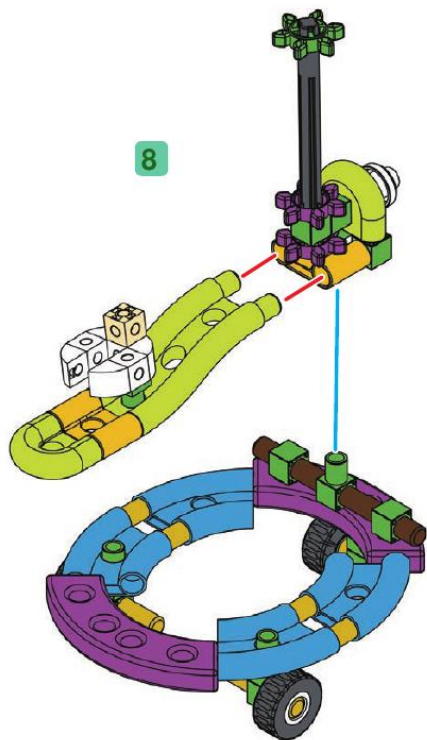

★ 組裝完成囉!
COMPLETE!

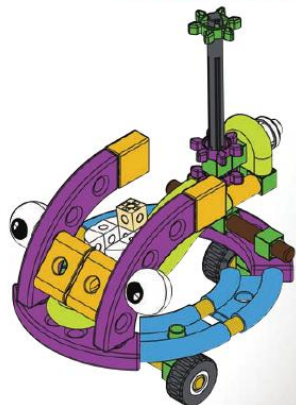

角色 Character

湯米

溫吞的好人，大家都沒有看他生氣過

Tommy

Gentle, never see him get angry.



x4



x1



x2



x2



x2



x2



x8



x1



x4



x4



x1



x1



x2



x1



x1



x3



x3



x2

2 遊園纜車 Tram

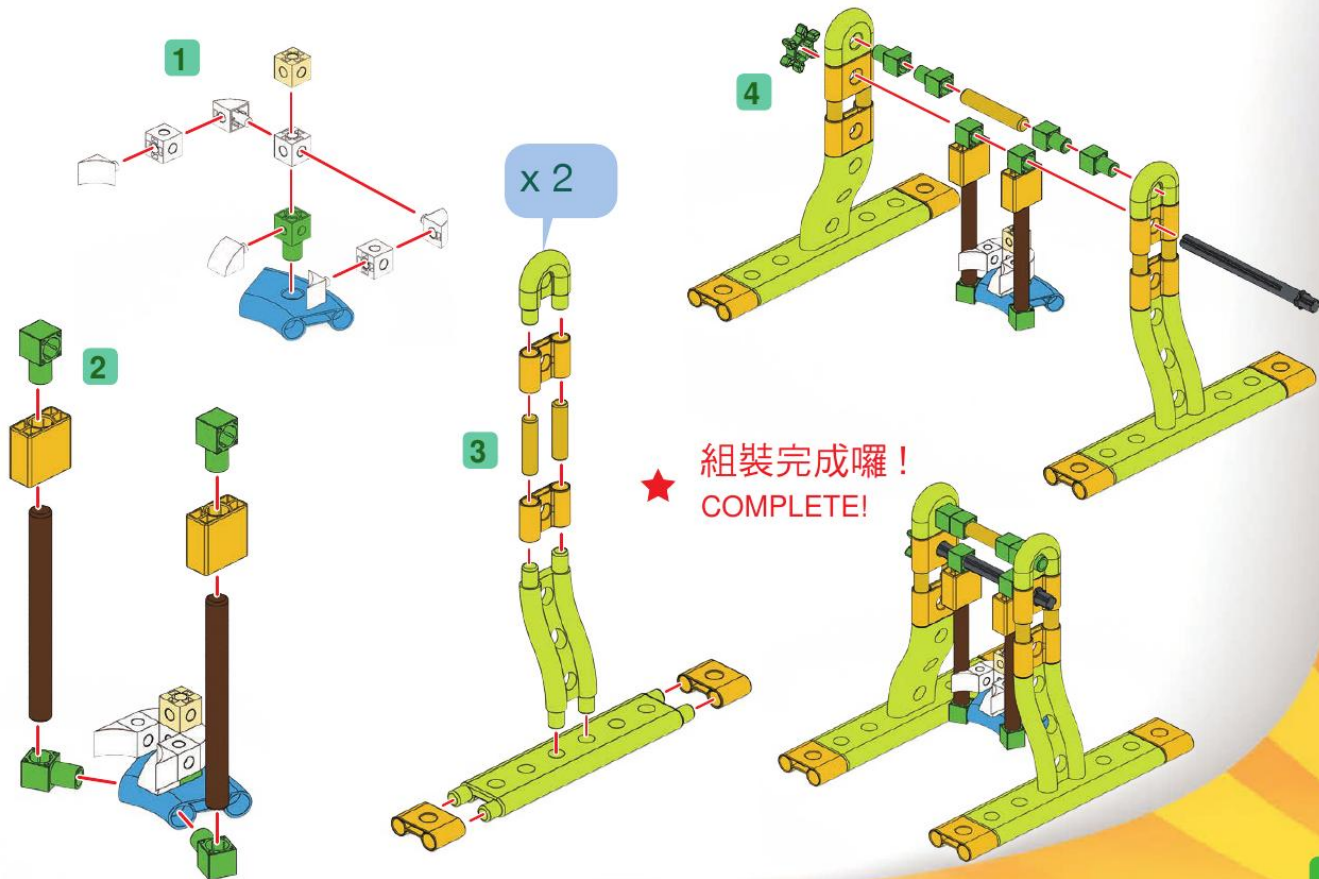

角色 Character

賴瑞

咻咻的好朋友，最喜歡
兩個人一起玩樂

Larry

Shushu's best friend,
love having fun together.



x1



x8



x2



x1



x1



x2



x2



x2



x8



x4



x5



x4



x3

3 滑水道 Waterslide 1



角色 Character









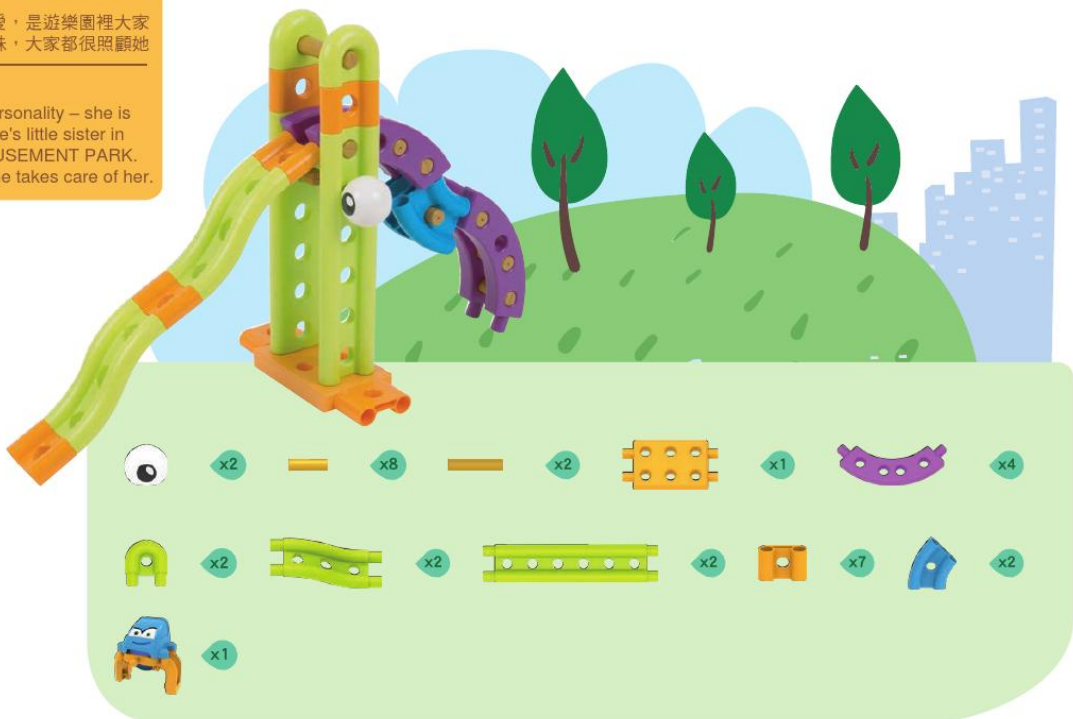

莎莉

個性可愛，是遊樂園裡大家的小妹妹，大家都很照顧她。

Sally

Cute personality – she is everyone's little sister in the AMUSEMENT PARK. Everyone takes care of her.



-  x2
-  x8
-  x2
-  x1
-  x4
-  x2
-  x2
-  x2
-  x7
-  x2
-  x1

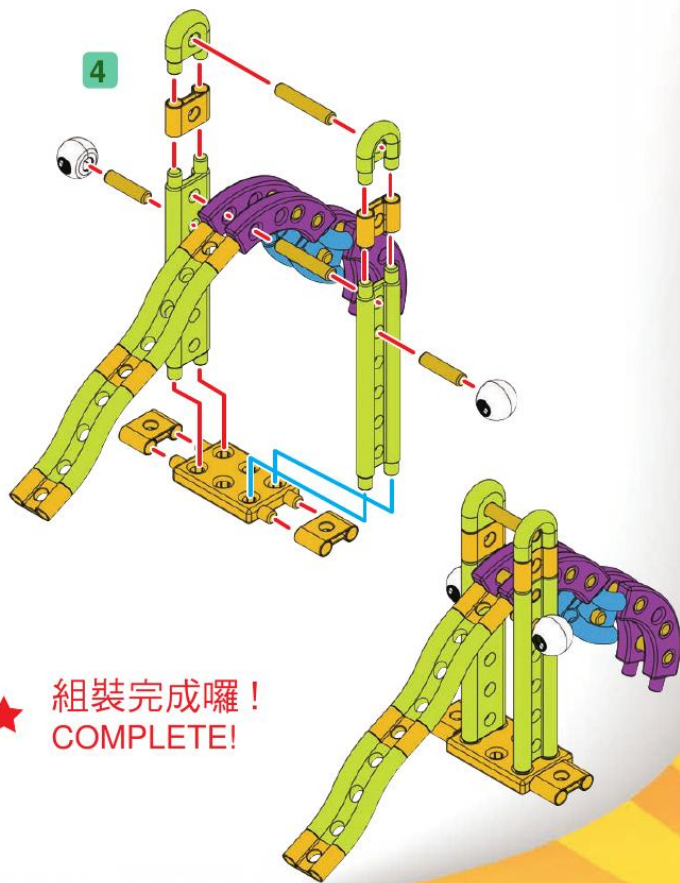
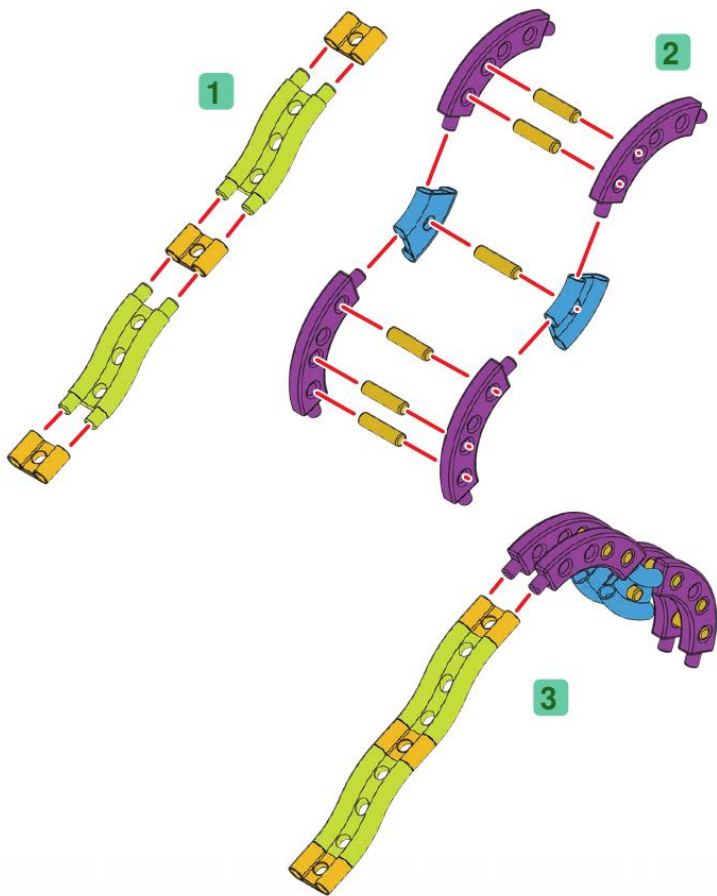

角色 Character

瑪莉

是遊樂園裡的小公主，
最喜歡蕾絲

Mary

Like a little princess in
the AMUSEMENT PARK,
favorite thing is lace.

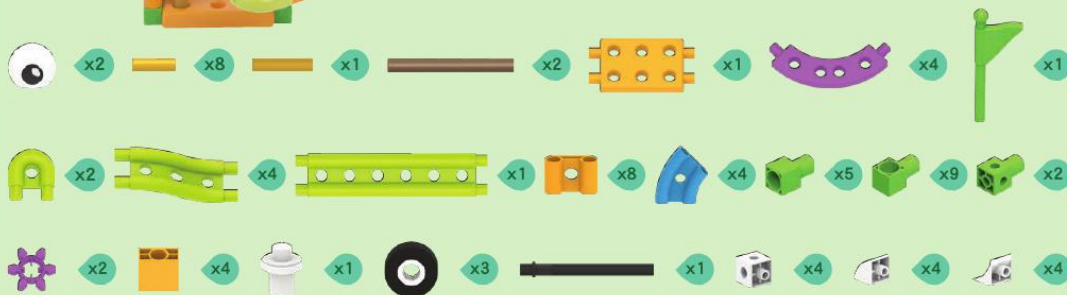

1

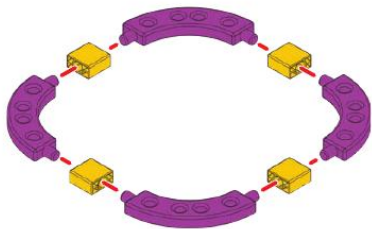

2

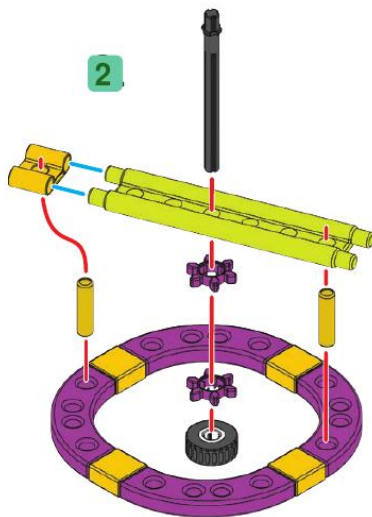

3

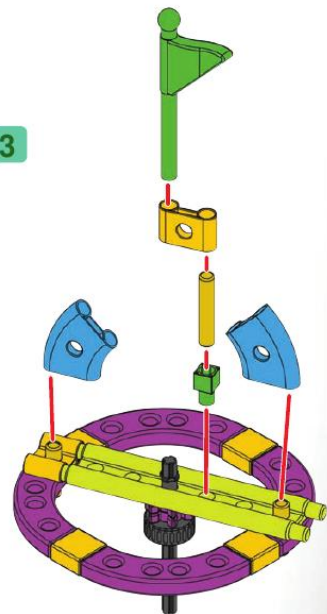

4

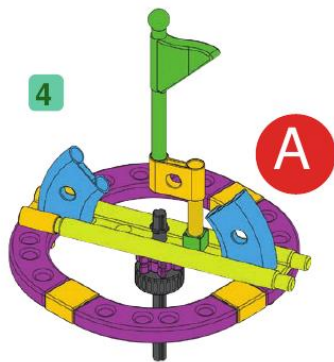

5

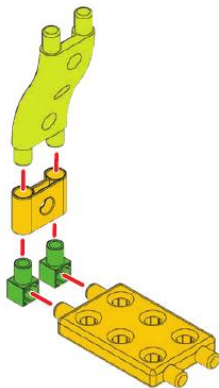

6

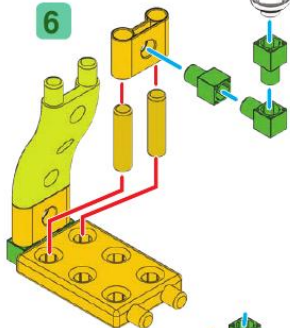

7

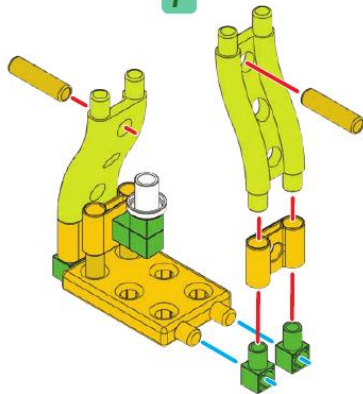

8

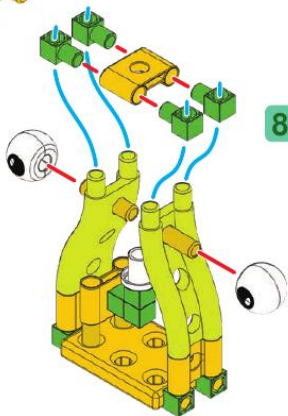

9

B

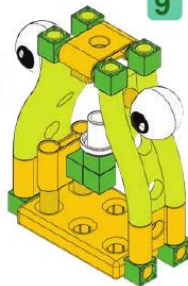

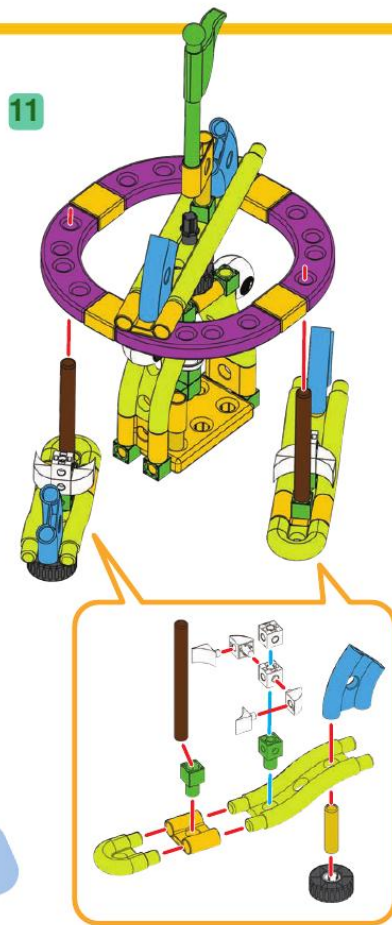
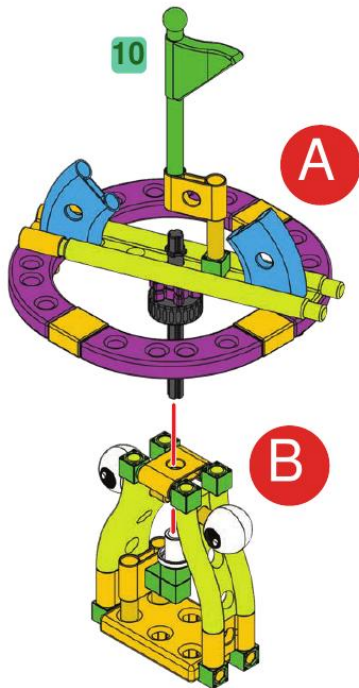

★ 組裝完成囉!
COMPLETE!

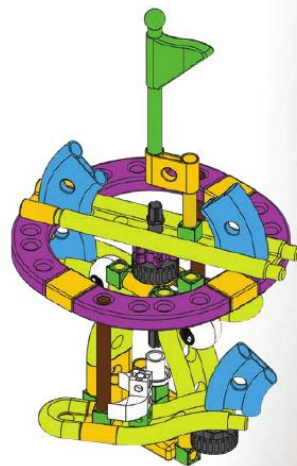

角色 Character

佩妮

個性調皮，喜歡捉弄人，
但是她沒有惡意

Penny

Mischievous personality,
likes to tease people,
but she is not malicious.

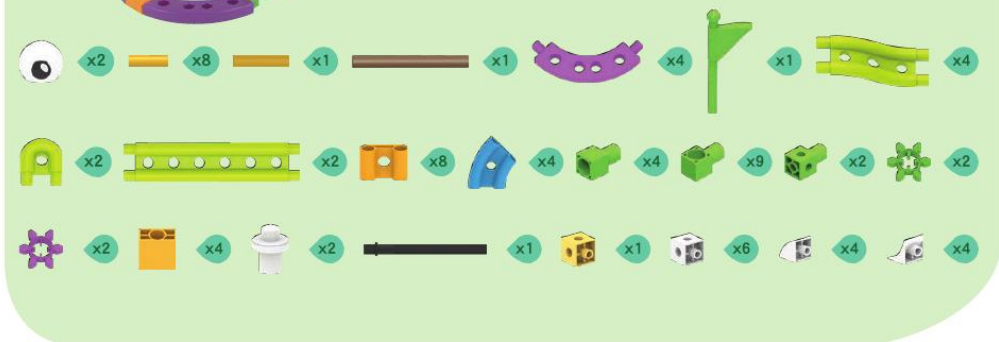

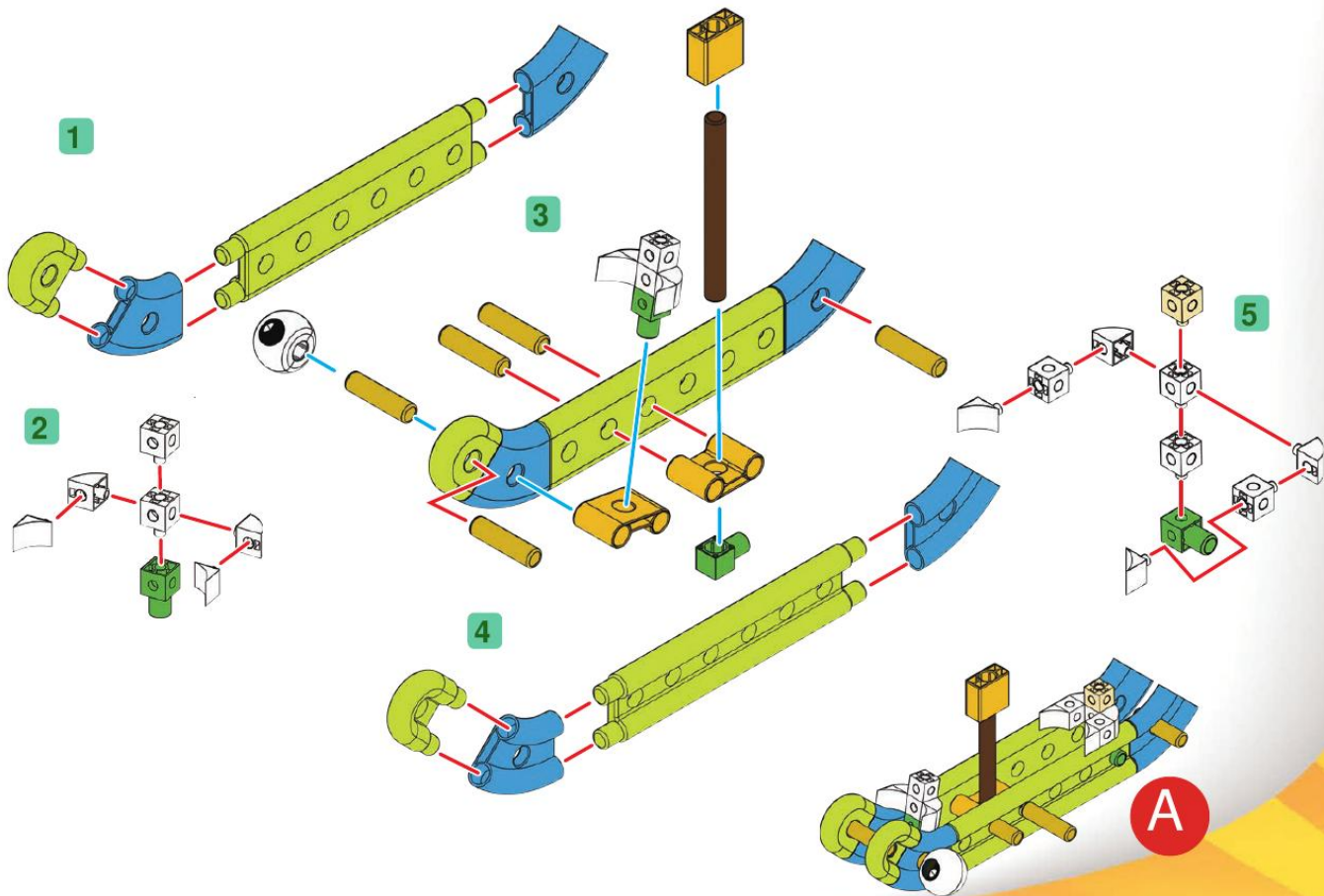

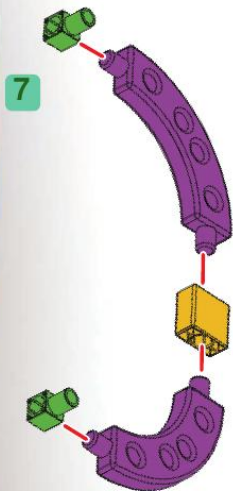

x 2

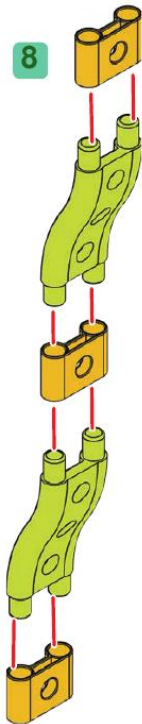

x 2

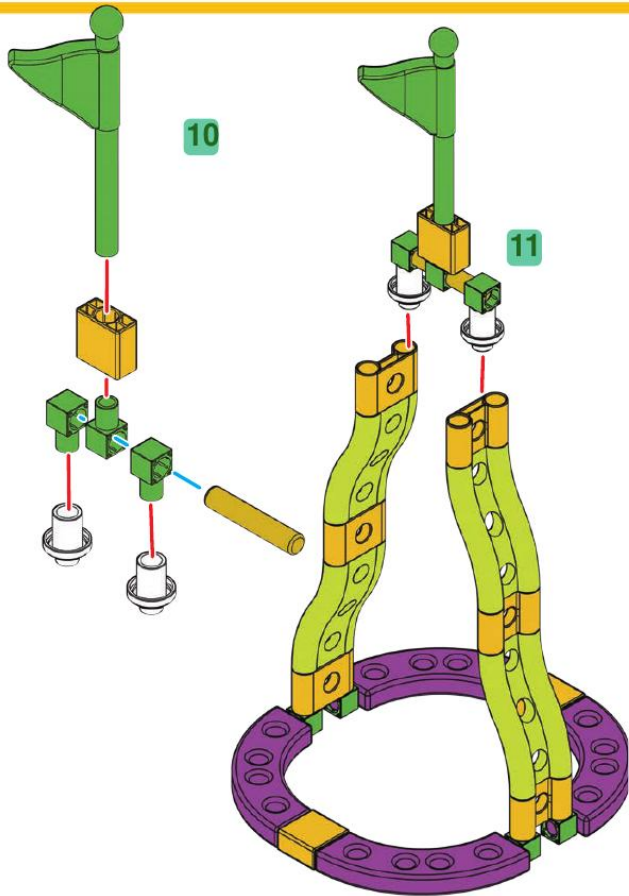
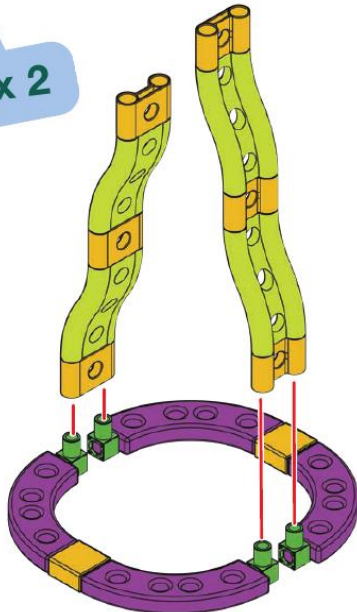

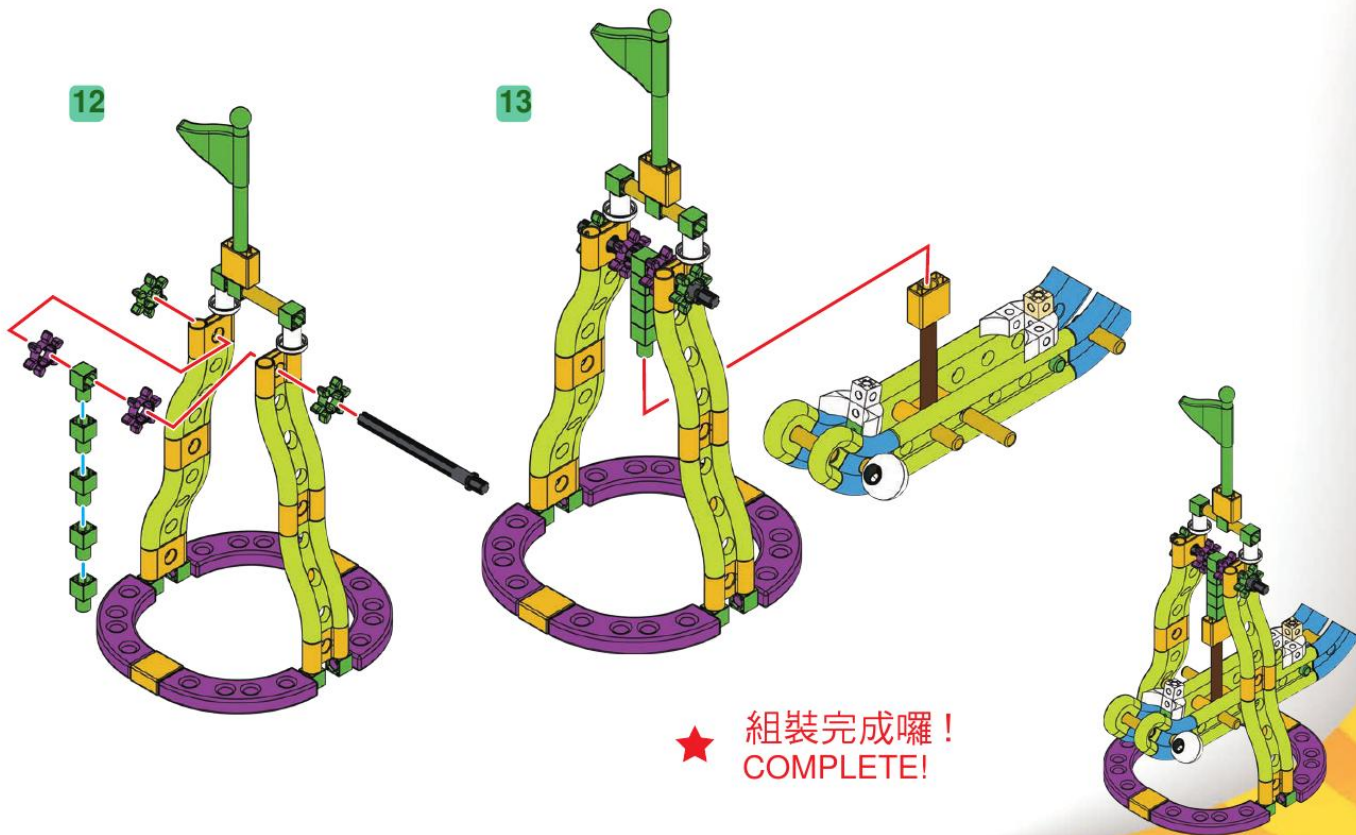

角色 Character

史考提

個性好動，靜不下來，
最喜歡小朋友在他身上玩耍

Scottie

Restless, favorite thing
is kids to play on him.

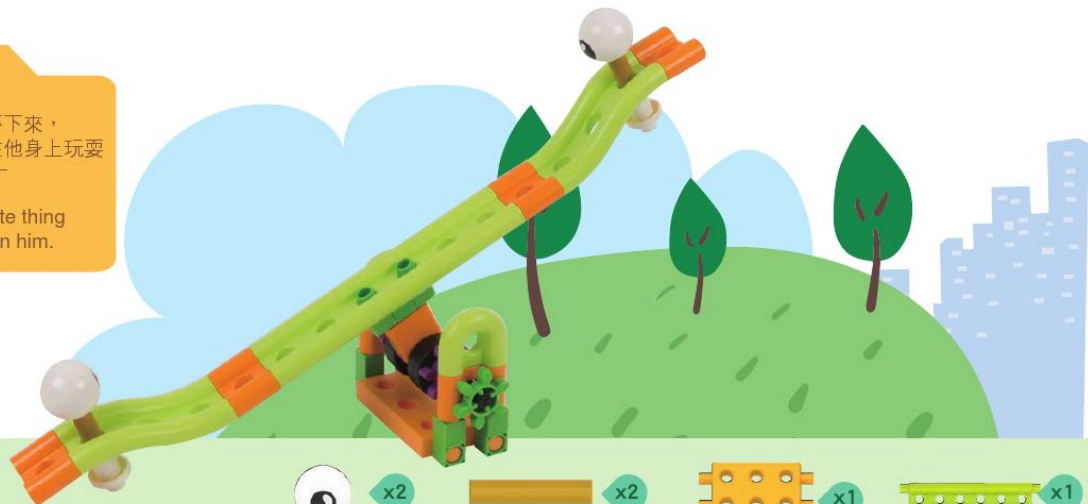

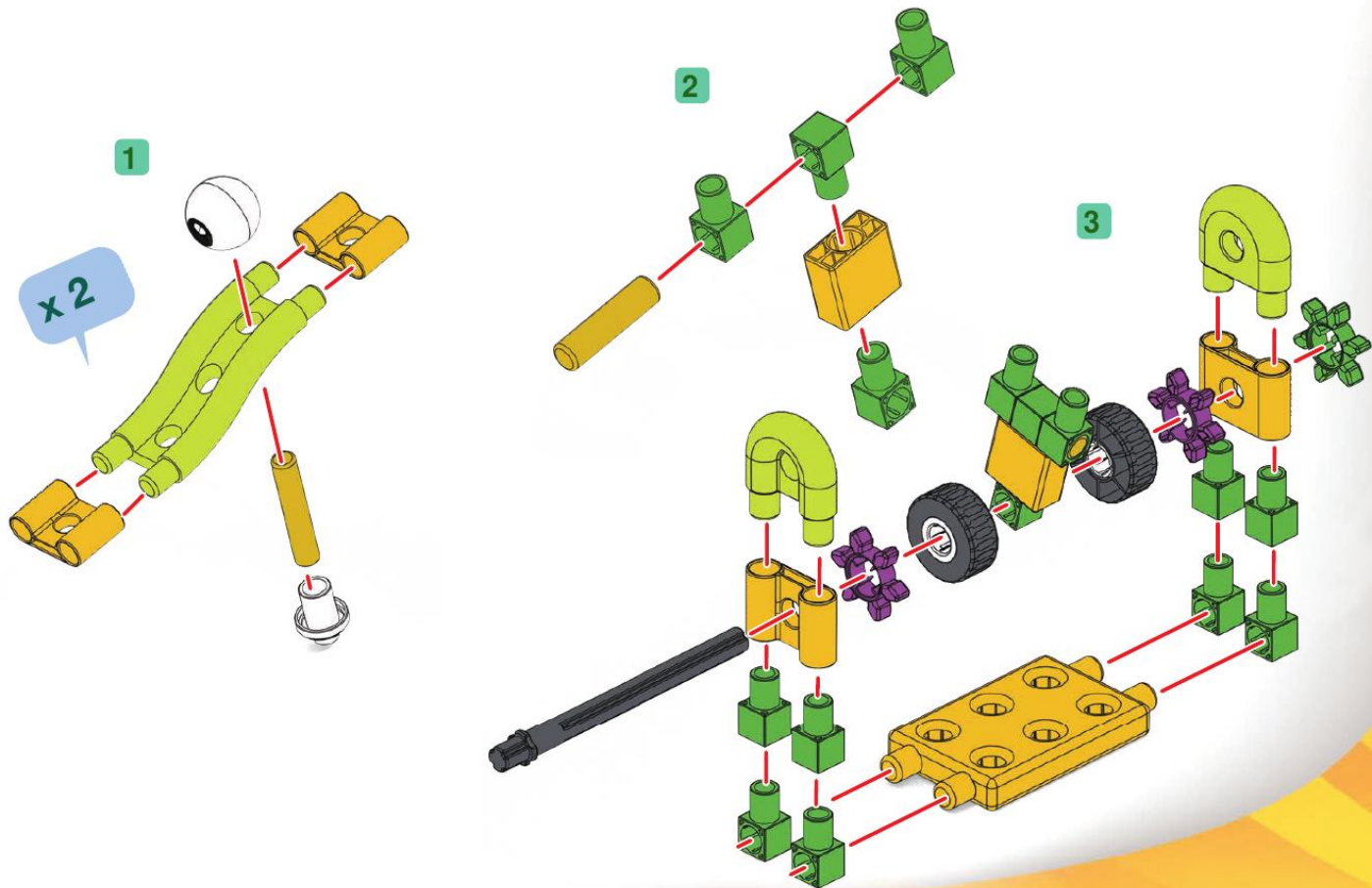

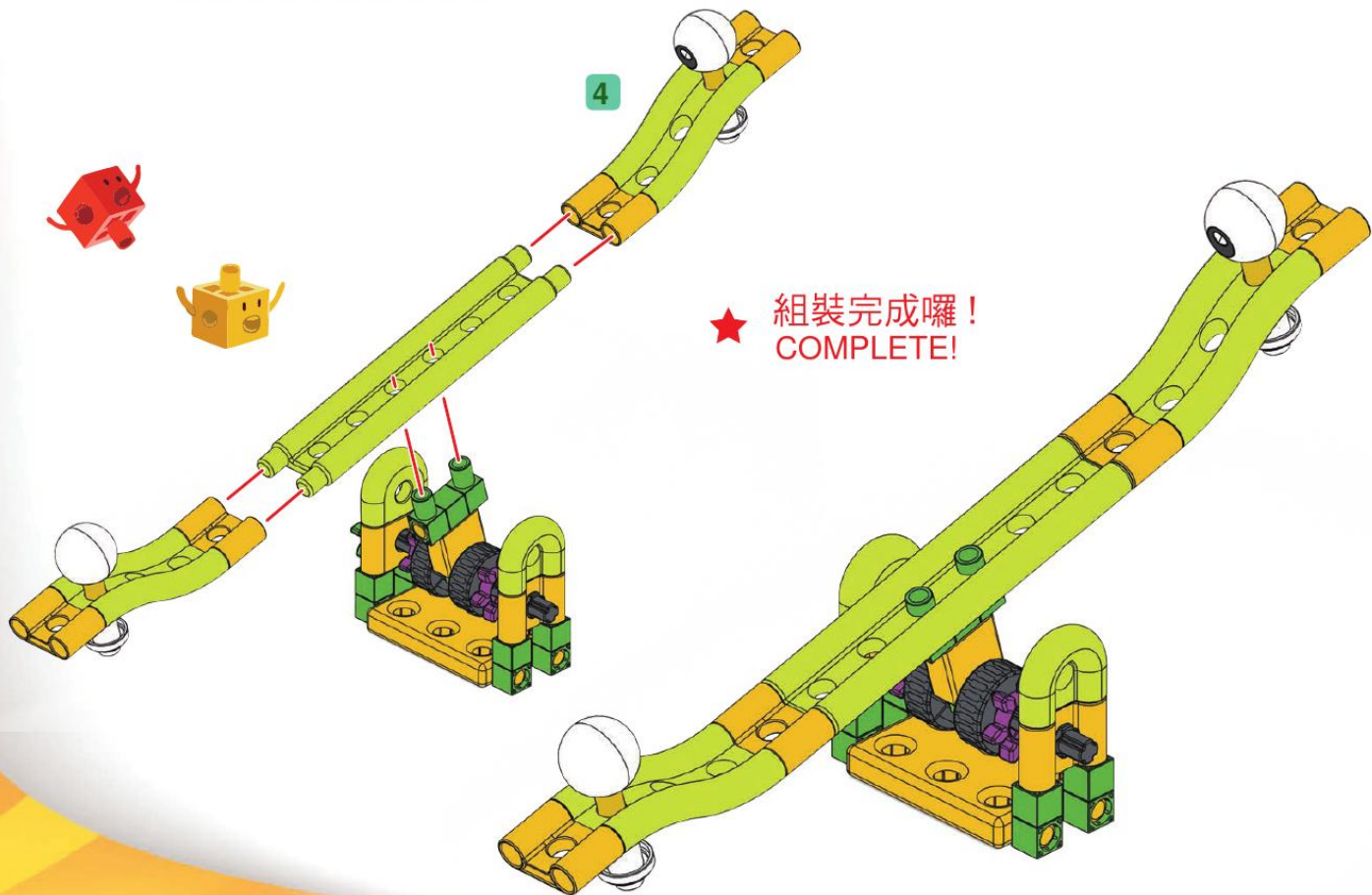

角色 Character

強尼
遊樂園裡的大哥哥，
大家沒事都最喜歡
去劇場看表演了

Johnny
Like a big brother in the
AMUSEMENT PARK.
Everyone loves to watch
his performance when
there is nothing to do.



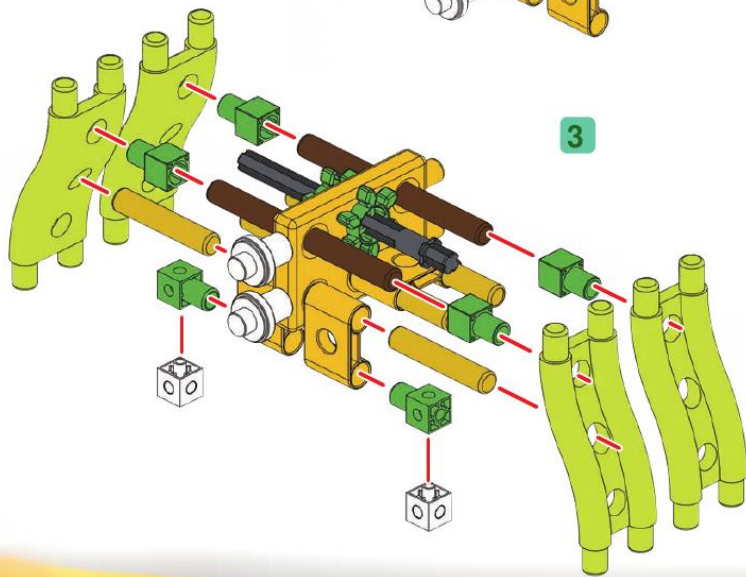
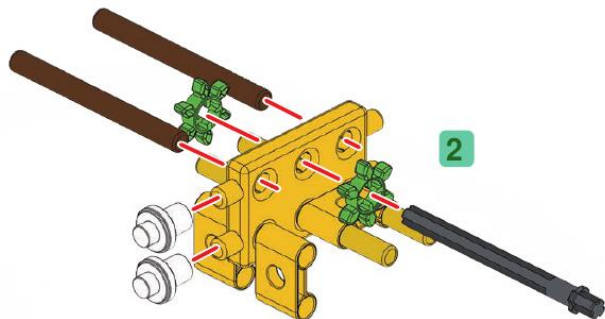
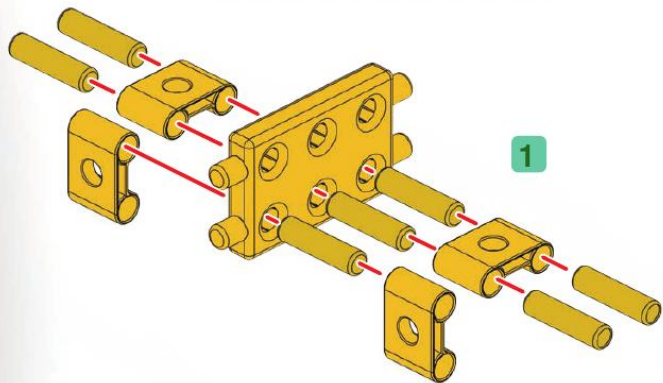

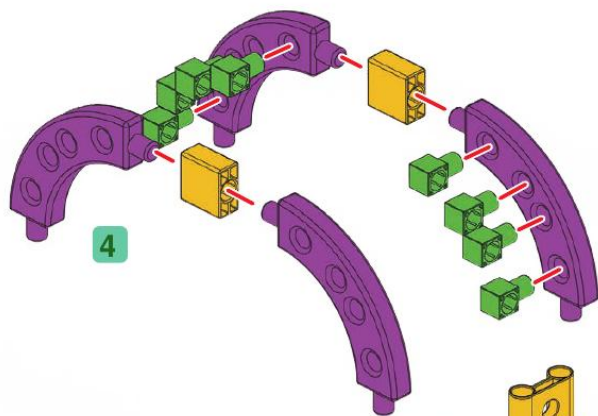

★ 組裝完成囉!
COMPLETE!

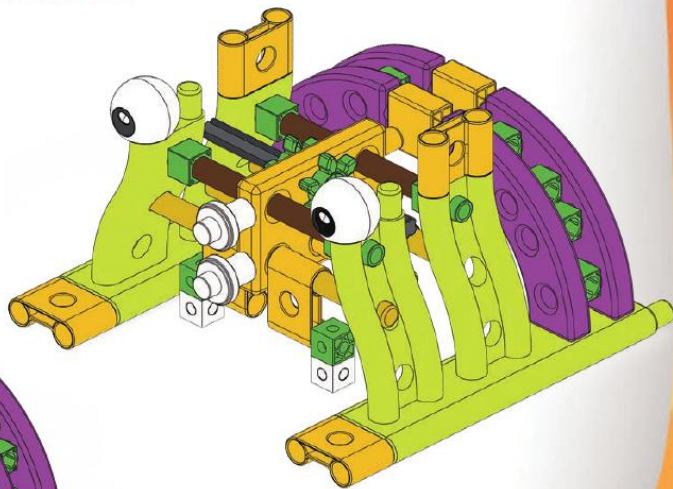
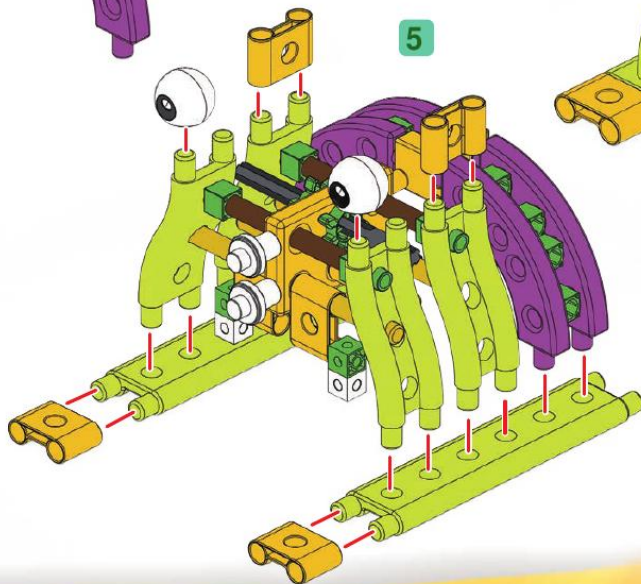

角色 Character

芬妮

個性直爽不做作，附有責任感，一定要確保大家的安全。

Fanny

Personality is not contrived, full of responsibility, always ensures everyone's safety.

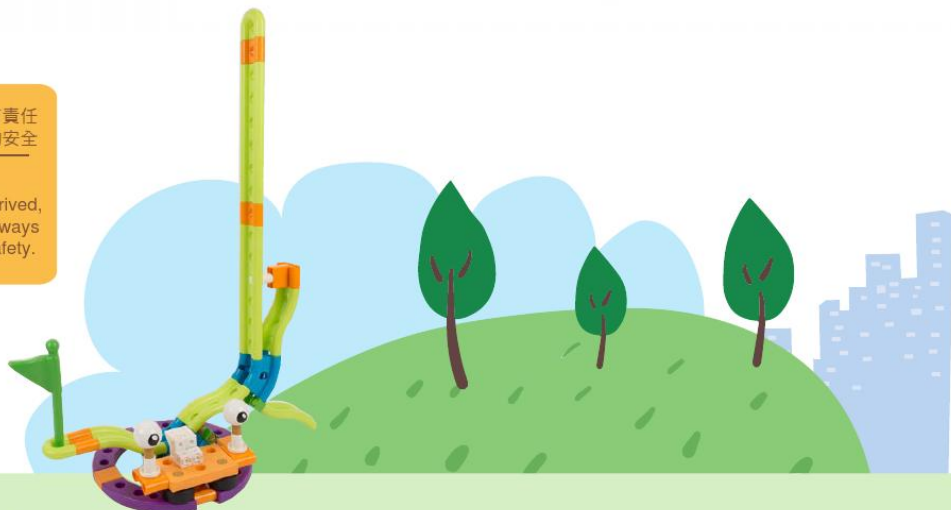

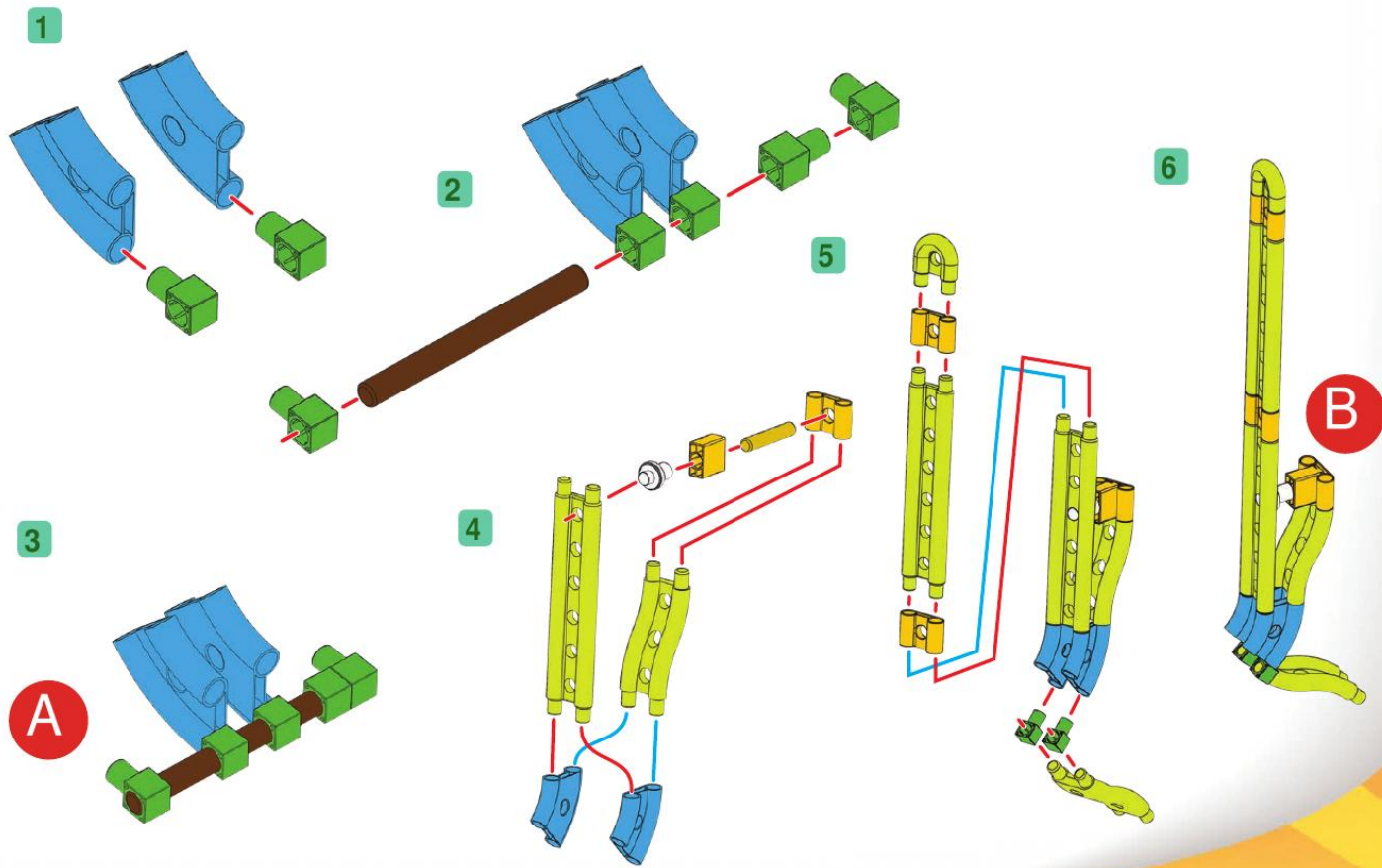

7

A

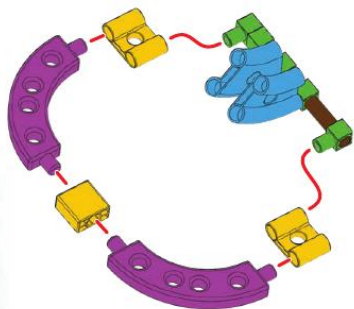

8

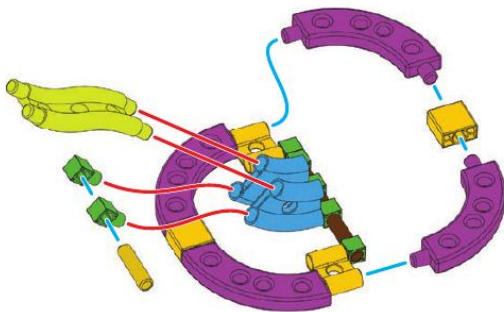

9

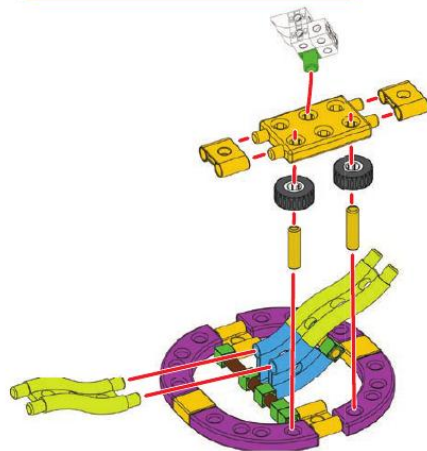
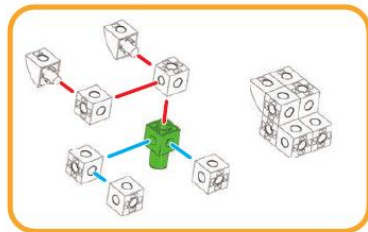

10

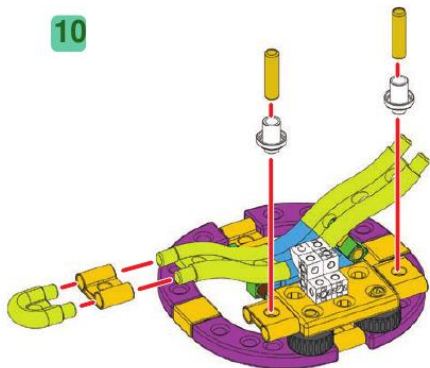

11

B

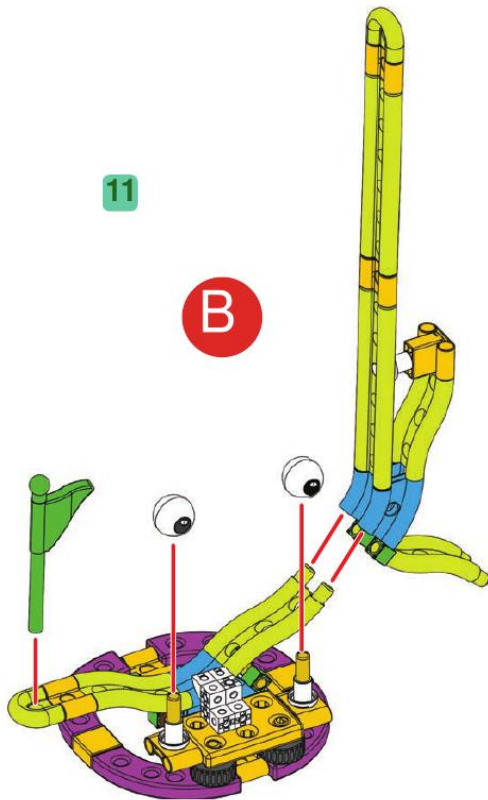

★ 組裝完成囉!
COMPLETE!



角色 Character

費理斯

是遊樂園的大家長，也是整個遊樂園的中心，是遊樂園裡最受歡迎的設施

Ferris

Like the big dad in the AMUSEMENT PARK, and also the centre of the AMUSEMENT PARK. He is the most popular facility.

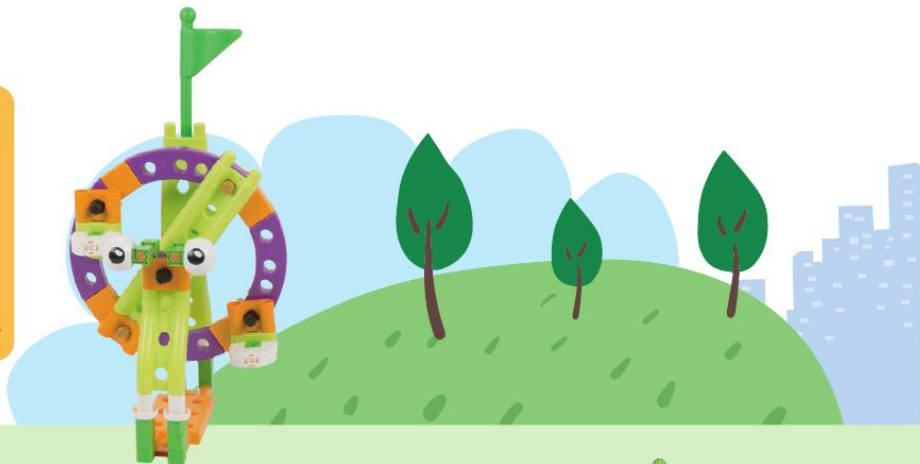

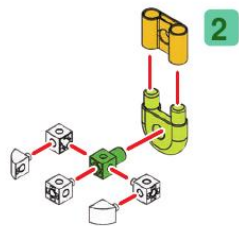
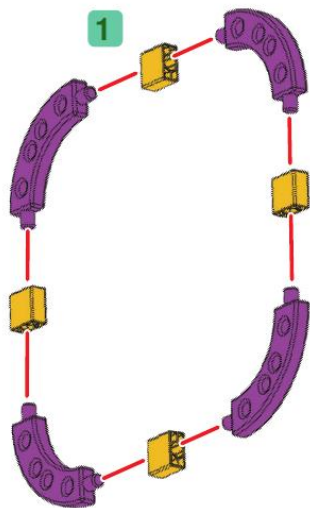

x 2

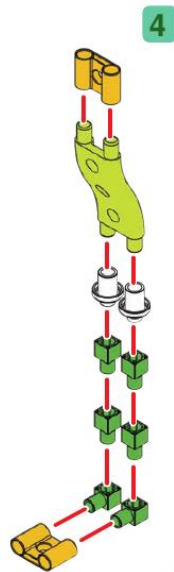
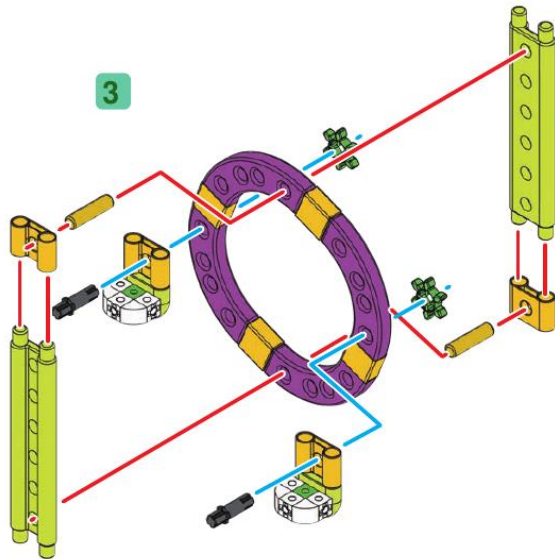

x 2

5

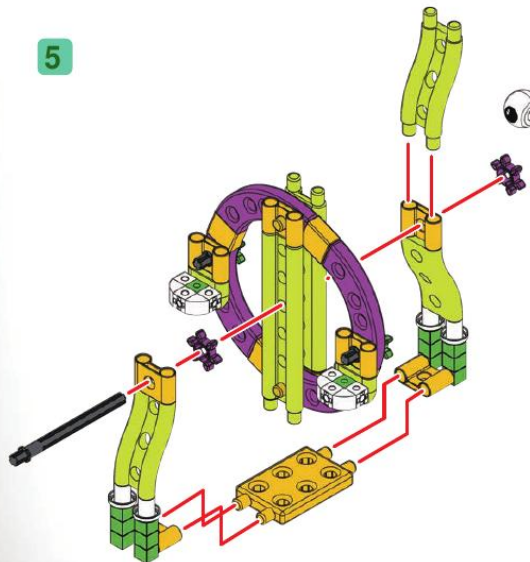

6

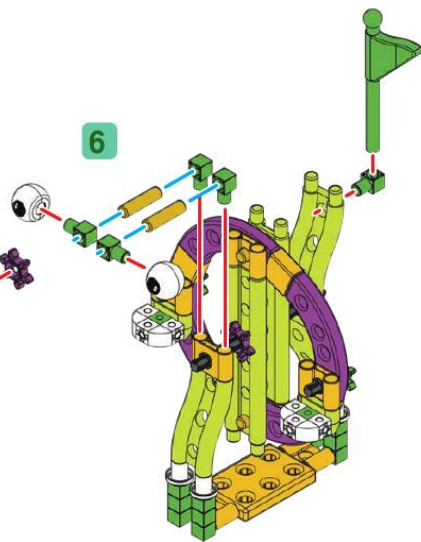

★ 組裝完成囉!
COMPLETE!

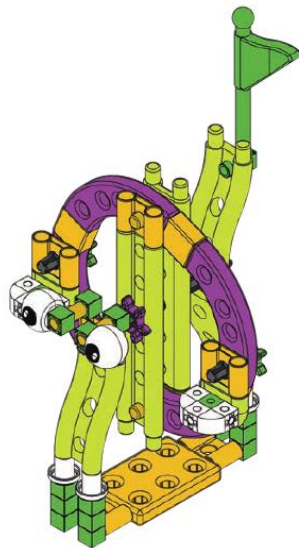

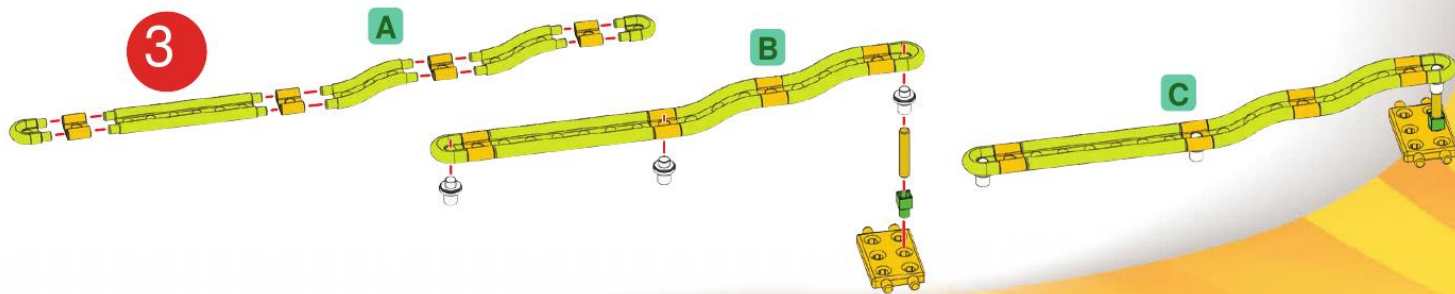
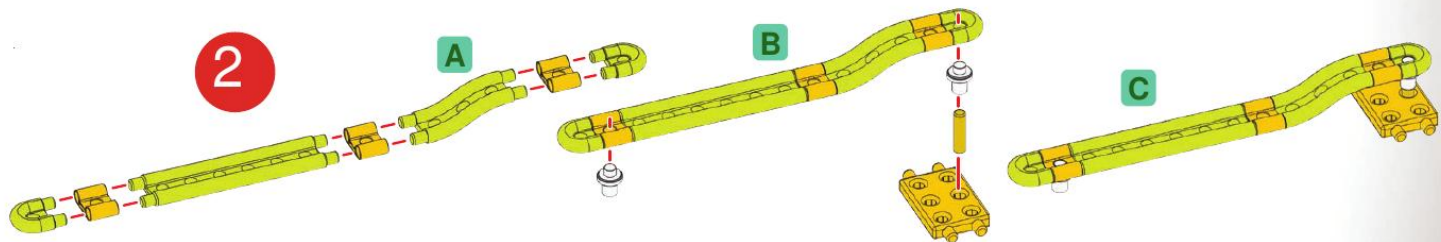
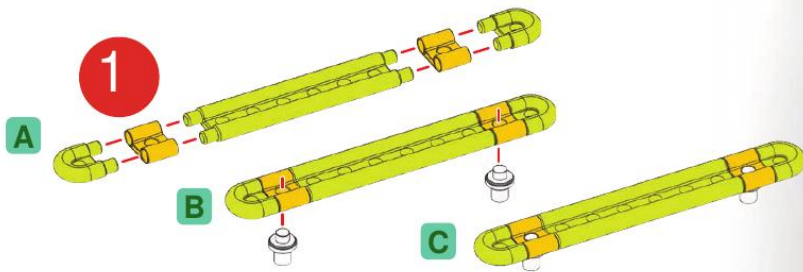
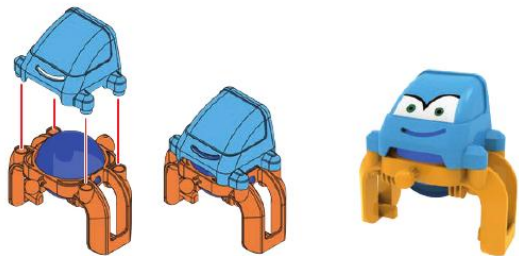

4

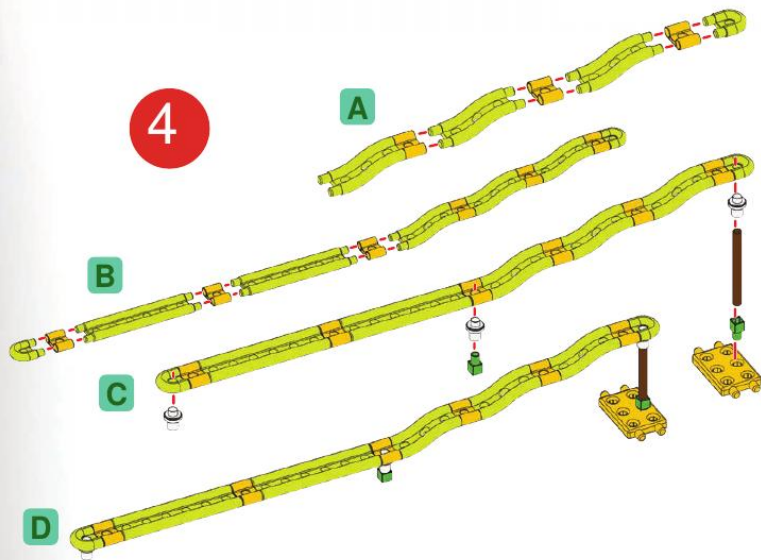

5

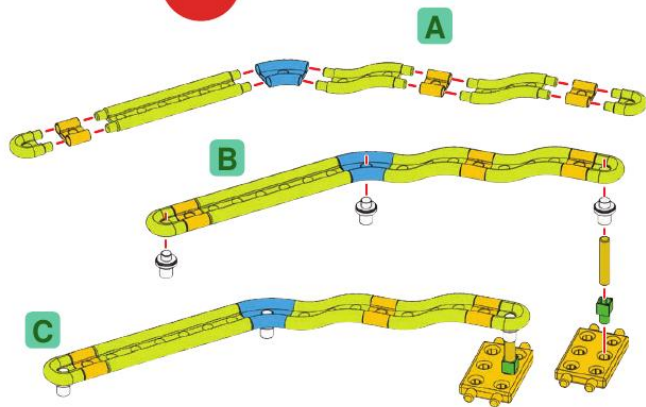

6

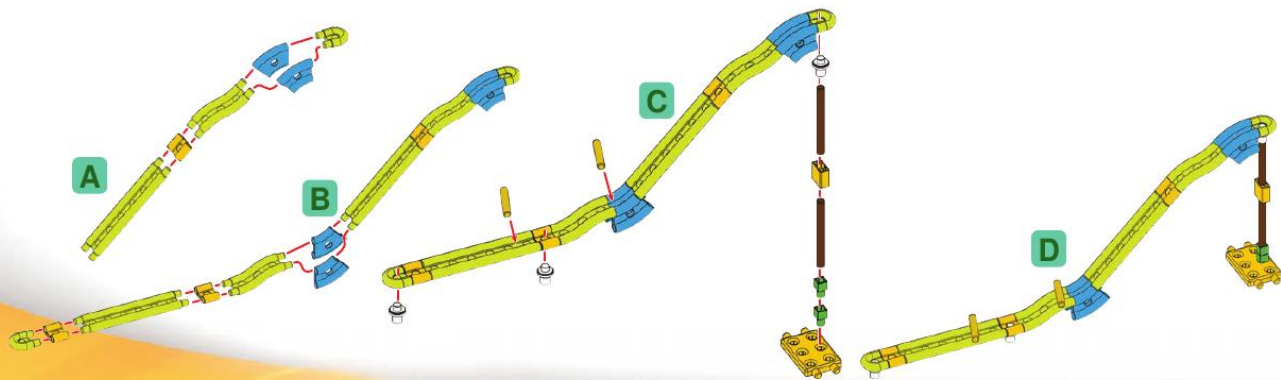

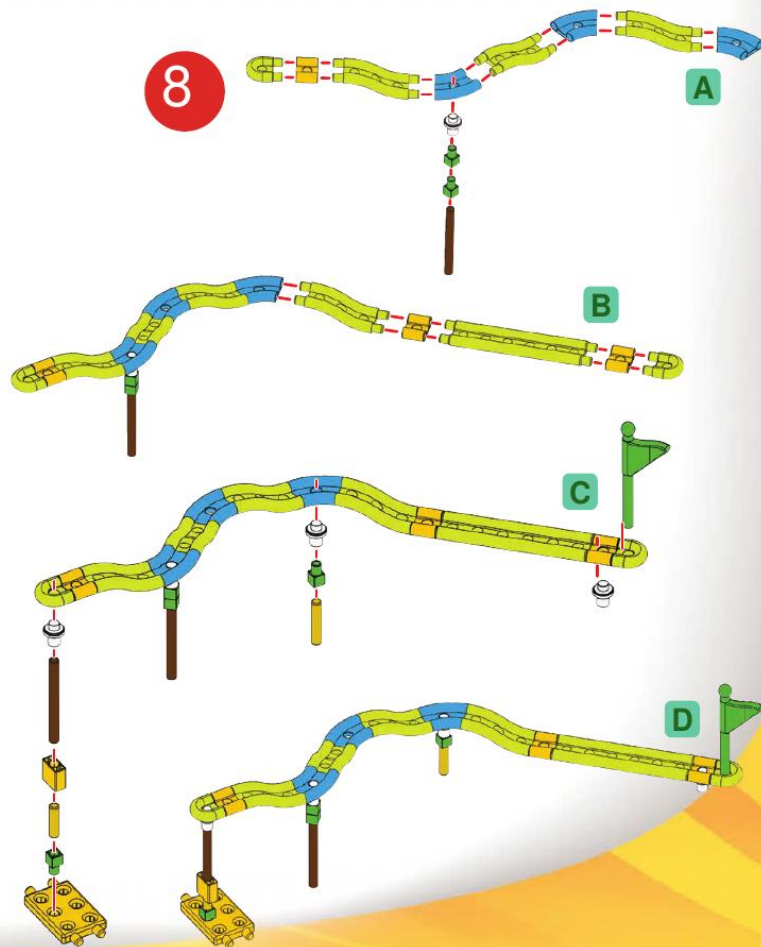
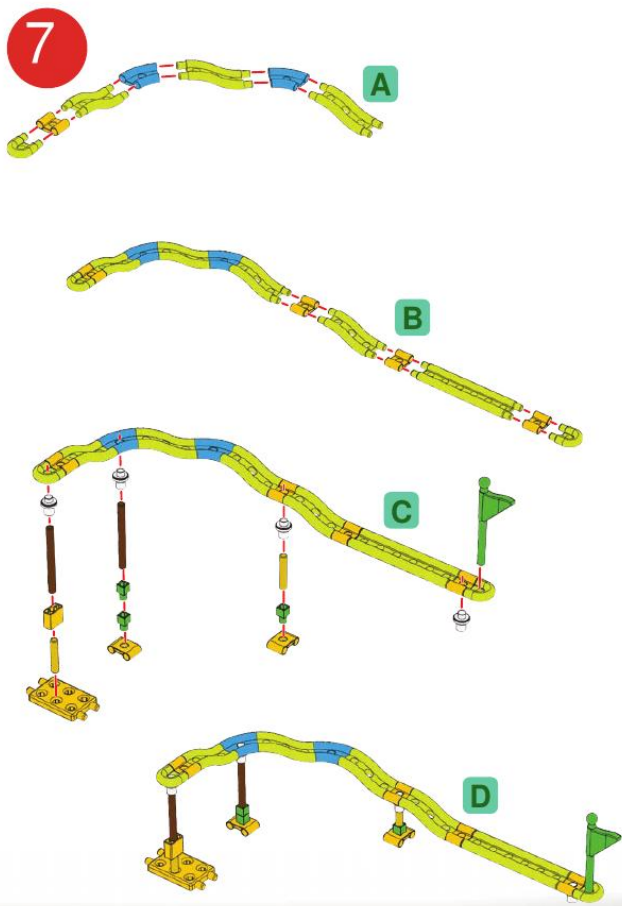

9

A

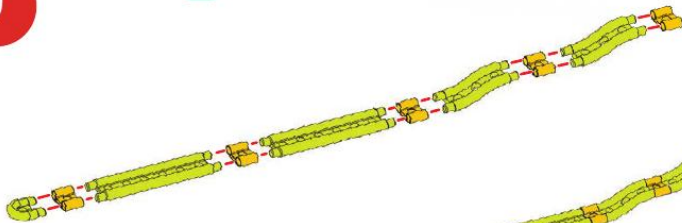

B

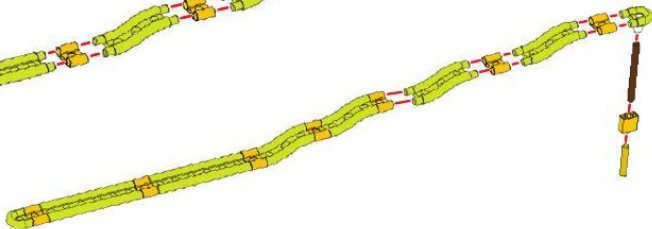

C

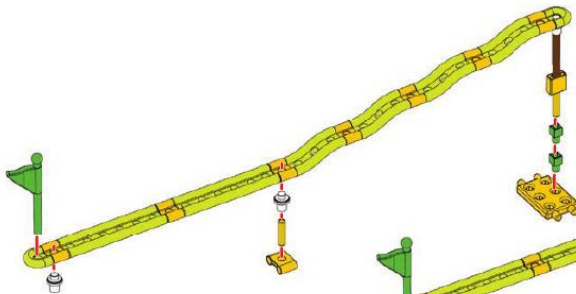

D

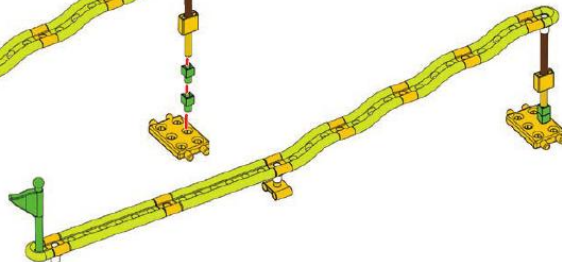

10

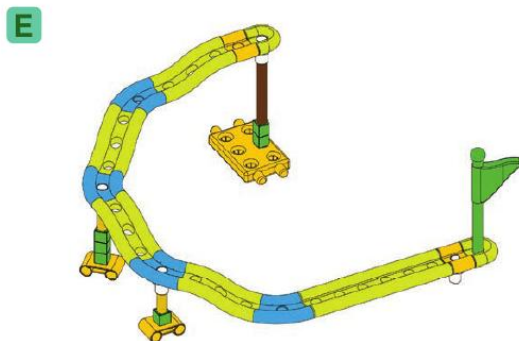
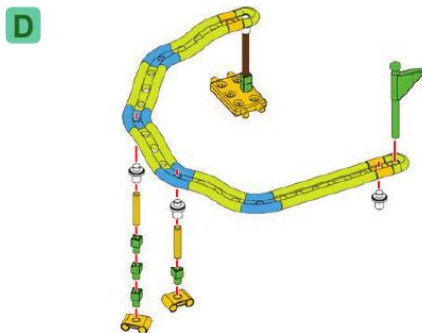
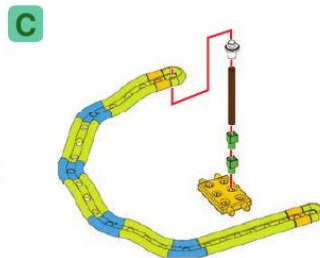
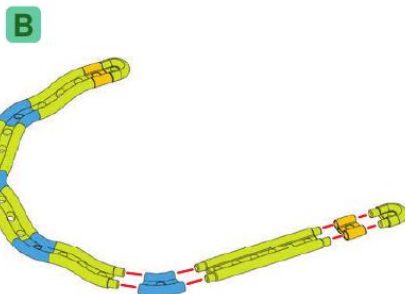
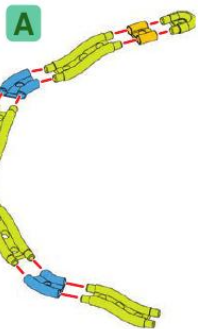

嗨，大家好，我是軌道車咻咻。

聽說，幸福遊樂園裡面有一個寶藏，
各位小朋友跟著我一起來尋找寶藏吧！



Hello, kids, I am Railcar Shushu.

I've heard there's a treasure inside the AMUSEMENT PARK.

Come and find the treasure with me.

嗨，碰碰車邦妮，妳有沒有聽說過，
幸福遊樂園裡面有一個寶藏啊？

Hi Bumper car Bonnie,
have you heard about the treasure in the AMUSEMENT PARK?

不好意思啊咻咻，

我現在還正在忙著跟別人撞來撞去呢。

I am sorry Shushu, I am so busy to bump with other cars right now.



也許我應該試著來問問看遊園纜車湯米。

Maybe I should ask Park Tram Tommy.

寶藏啊，我沒有聽說耶，

不過我可以先載你繞幸福遊樂園一圈，

Treasure? Never heard of it.

But I can show you around the AMUSEMENT PARK.

我們可以一起找找看。

We can find it together.



啊！那是我×的好×朋友×滑×水×道×賴×瑞×！

Hey! That's my good buddy Waterslide Larry!



嘿～ 咻咻～ 快來快來，我×們×一×起×玩×最×好×玩×了×！

Come on Shushu, join me, we can have so much fun.

啊～玩得_ㄉ太_ㄉ開_ㄉ心_ㄉ都_ㄉ忘_ㄉ記_ㄉ問_ㄉ賴_ㄉ瑞_ㄉ寶_ㄉ藏_ㄉ的_ㄉ事_ㄉ了_ㄉ，
不_ㄉ然_ㄉ去_ㄉ問_ㄉ看_ㄉ賴_ㄉ瑞_ㄉ的_ㄉ妹_ㄉ妹_ㄉ莎_ㄉ莉_ㄉ。

Oh, I forgot to ask Larry about the treasure in the AMUSEMENT PARK,
we always play too much. I can ask Larry's sister Sally.

莎_ㄉ莉_ㄉ妳_ㄉ知_ㄉ道_ㄉ幸_ㄉ福_ㄉ遊_ㄉ樂_ㄉ園_ㄉ裡_ㄉ面_ㄉ的_ㄉ寶_ㄉ藏_ㄉ嗎_ㄉ？

Sally, do you know anything about the treasure in the AMUSEMENT PARK?

我有聽海盜船佩妮說過，
不過她在園區的另一外頭，
我請旋轉木馬瑪莉帶你轉到那邊去。

I've heard from Pirate Ship Penny,
but she is on the other side of the AMUSEMENT PARK.
I'll ask Merry-go-round Mary toward the right direction.

謝謝妳們的幫忙，妳們最棒了。
Thank you, you are both so sweet.





嗨！佩妮！我想跟你打聽幸福遊樂園寶藏的事。

Hey Penny, I would like to ask you about the treasure in the AMUSEMENT PARK.

咻咻，那你先坐上來，

如果你都沒有頭暈的話，我就告訴你，

不過我可是會盪得很高的唷！

Shushu, then you must ride on me first.

I will tell you but only if you don't feel dizzy.

BUT I am going to swing SO HIGH!

啊... 我的頭好暈，我需要休息一下。
史考提借我坐一下好嗎？

Ah... I feel so dizzy, I need to sit down.
Can I sit on you See-saw Scottie?

好啊！不過我會一直上上下下的喔！
Sure, but I am not going to stop up and down !

嗚... 我的頭更暈了。
Oh... I feel much dizzier...



咻咻！你過來我這裡休息一下吧，

只有劇場讓你可以在舒服的椅子上看表演。

Shushu, come over here,

you can sit on a comfortable chair and watch the performance.

皇宮劇場強尼，你真是個好人！

那你知道幸福遊樂園的寶藏在哪裡嗎？

Palace Theatre Johnny, you are the best!

Do you know where the treasure in the AMUSEMENT PARK is?

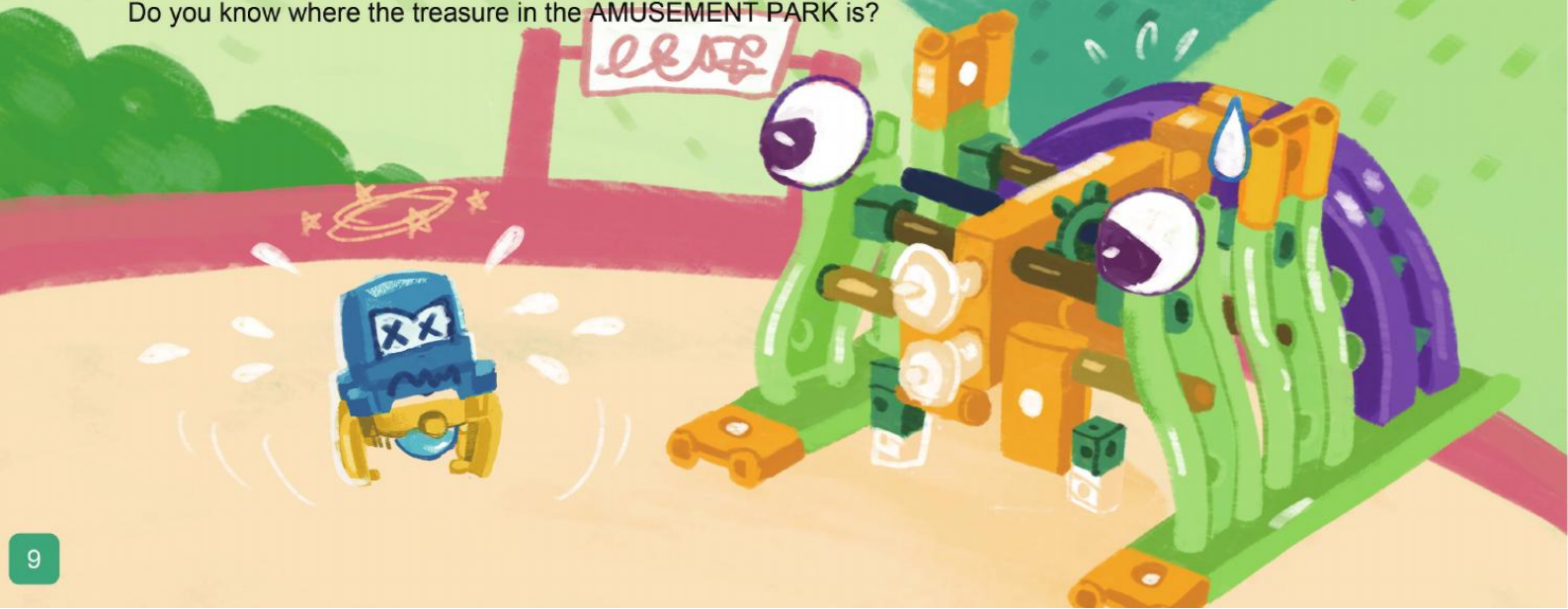

強尼說也許可以問雲霄飛車芬妮，
可是我該不會又要再坐一次雲霄飛車吧……

Johnny said I can ask Roller Coaster Fanny,
but...I would not have to sit through the ride again, right?

當然要啊～

要找寶藏就要挑戰

幸福遊樂園中最刺激的雲霄飛車！

You certainly have to! You will have to challenge
the most exciting Roller Coaster in the AMUSEMENT PARK,
if you want to find the treasure in the AMUSEMENT PARK.

啊Y 啊Y 啊Y 啊Y 啊Y ~ ~ ~ ~ ~
Ah ~ ~ ~ ~ ~



咻咻恭喜你通過考驗啦，

給你最後的提示，去找摩天輪費理斯吧！

Shushu, congratulation!
you pass the task, I will give you the last hint.

Go find Ferris Wheel Ferris!

咻咻你坐上來，

我帶你去看看幸福遊樂園的寶藏。

Shushu, come on,

I will show you the treasure in the AMUSEMENT PARK.

原來這就是幸福遊樂園的寶藏，真的好美啊！

Wow, so this is the treasure in the AMUSEMENT PARK. It really is so beautiful!

