

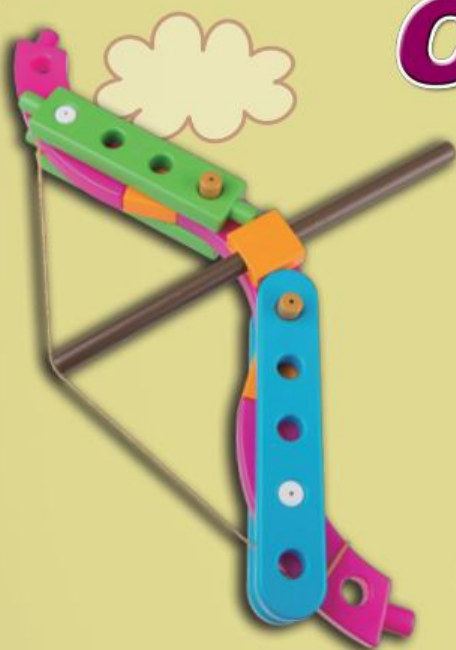

創意探險家 CREATIVE GYM

FUN LAB



1272

56 PCS

3+

知識來自於經驗

KNOWLEDGE COMES
FROM EXPERIENCE ALONE



20 MODELS
TO BUILD

$(x) = \frac{d}{3}$; $x \sqrt{x}$

前言 /Introduction	P2
零件表 /Parts List	P3~4
課程準備 /Class Preparation	P5
荷花 Lotus Flower	P6
藥碾子 Mortar and Pestle	P7
向日葵 Sunflower	P8
喇叭花 Morning Glory Flower	P9
豬籠草 Nepenthes Flower	P10~11
平衡球 Balance	P12
滾球遊戲 Bowling	P13
傳球遊戲 Pass the Ball	P14
彈球遊戲 Pinball	P15~16
拋接遊戲 Throw and Catch	P17~18
刮胡 Güiro	P19
小喇叭 Small Speakers	P20~21
薩克斯風 Saxophone	P22~23
爵士鼓 Jazz Drum Set	P24~25
吉他 Guitar	P26
足球 Football	P27
滾圈圈 Spinning Hoop	P28~29
高爾夫球 Golf	P30
籃球 Basketball	P31~32
弓箭 Bow and Arrow	P33~34

各位小朋友，歡迎你加入 Gigo 智高的 FUN LAB 趣味實驗室。

在 FUN LAB 趣味實驗室中有許多的智高積木，這些形色多樣的積木能重複使用，做出千萬種變化，同時還能省時省力，是我們接下來要進行一連串有趣好玩實驗的最佳幫手哦！在我們親手組裝及操作積木的過程中，不僅能夠體會組裝創作的樂趣，還能夠學習到許多知識，例如：色彩搭配的美學、簡單的機械原理、綠色能源的應用、科技積木的體驗、創意的機關製作...等。而且，我們還可以和好朋友團隊合作，加入自己的想法，激發創意，打造出獨一無二的積木模型。跟隨我們在這座實驗室裡一步一步地探索，快樂地學習各種知識，除了能培養我們正確的學習態度及解決問題的能力，更能將這些知識活用於日常生活，進而學習創新的技巧與能力。

看到這裡，相信各位小朋友都已經迫不及待了，那麼，就讓我們一起進入充滿樂趣的 FUN LAB 趣味實驗室吧！

Welcome to Gigo's FUN LAB!

FUN LAB includes several key pieces which can create millions of variations that can enable us to conduct a series of fun and interesting experiments. During assembly, not only is it fun but participants can improve several important skills, such as: color-matching, basic mechanics, utilizing green energy, making creative models ... and much more. Also, you can work as a team with your friends and use your own ideas to create something unique.

Follow us step by step in the FUN LAB to increase your overall knowledge. In addition to cultivating a positive attitude towards learning, you will gain more problem-solving and improvisational skills to deal with your daily life.

Now I am sure you cannot wait, let's jump in and start Fun Lab!

1



A-單孔固定軌道
A-1 HOLE TRACK
x2

2



A-軌道結合器
A-TRACK CONNECTOR
x5

3



A-單孔單向軌道
A-TRACK END
x4

7



A-4 孔長條
A-4 HOLE ROD
x2

8



A-5 孔圓長條
A-5 HOLE ROUND ROD
x2

9



A-3 孔圓長條
A-3 HOLE ROUND ROD
x2

13

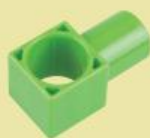

A-90度結合器
A-LATERAL PEG
x5

14



A-直線結合器
A-FRONT PEG
x4

15



A-2x3 孔長方框
A-2x3 HOLE BASE
x1

19



A-3 孔斜坡軌道
A-SLIDE TRACK
x2

20



A-3x4 孔長方框
A-3x4 FRAME
x1

21



A-4 孔 1/4 弧長條
A-4 HOLE BENDED ROD
x4

4



A-60mm 圓棒
A-60mm CONNECTOR
x5

5



A-OD70x20mm 塑膠輪
A-OD70 WHEEL
x1

6



A-OD50x20mm 塑膠輪
A-OD50 WHEEL
x1

10



A- 半圓球體
A-HEMISPHERE
x1

11



A-160mm 圓棒
A-160mm CONNECTOR
x2

12



A-80mm 圓棒
A-80mm CONNECTOR
x3

16



A-18T 自轉齒輪
A-18T GEAR WITH ADAPTER
x1

17



A- 單孔結合器
A-ROD CONNECTOR
x4

18

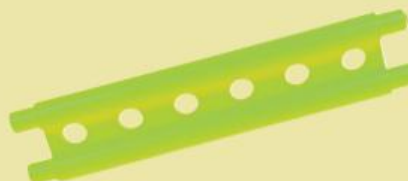

A-6 孔直線軌道
A-6 HOLE TRACK
x1

22



A-50mm 圓球
A-50mm BALL
x1

23



C-200mm 橡皮筋 鍵
C-200mm RUBBER BAND
x2

課前準備 *Class preparations*

轉接器拆解技巧

Peg dismantling tips

90度轉接器

Lateral peg



直線轉接器

Front peg



軌道的方向

The direction of the track



組裝時請注意正反面

Note the front and the back while assembling.

圓棒

Connector



轉動圓棒，較容易組裝進去

Turn the connector around to make assembling easier.



輕敲桌面，較易於拆裝

Tap the connector on the desktop to make disassembling easier.

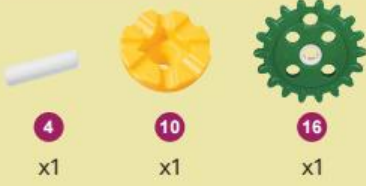

1

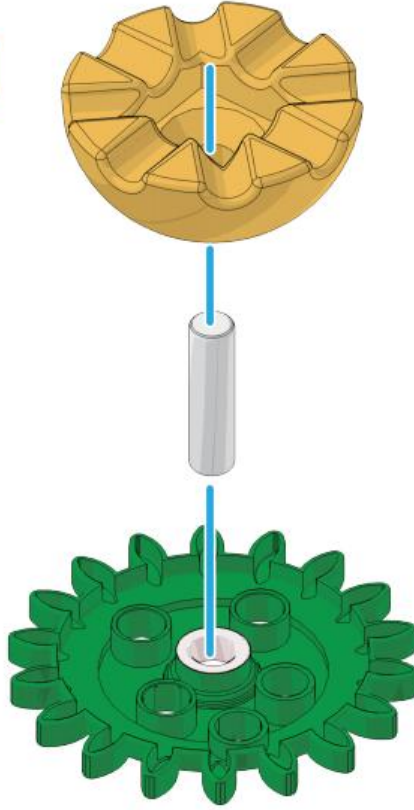

完成
Done

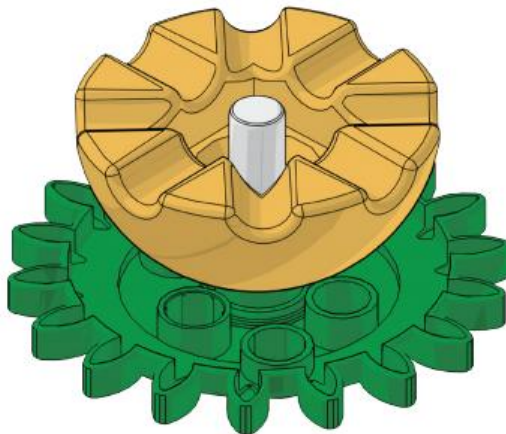

藥碾子

Mortar and Pestle

需用零件 Parts Needed



2
x1



3
x2



5
x1



11
x1

1

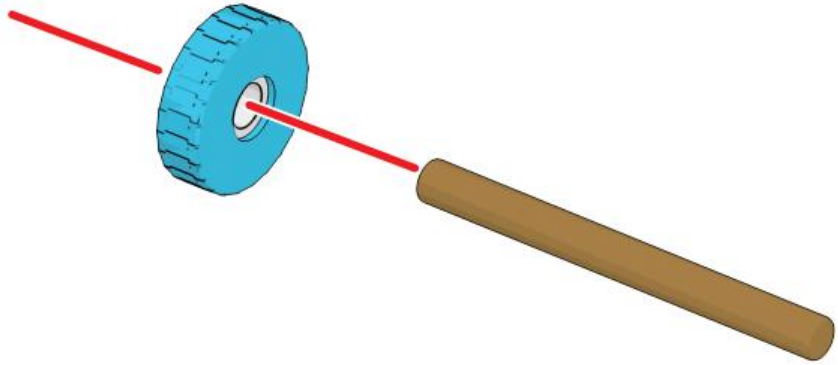

2

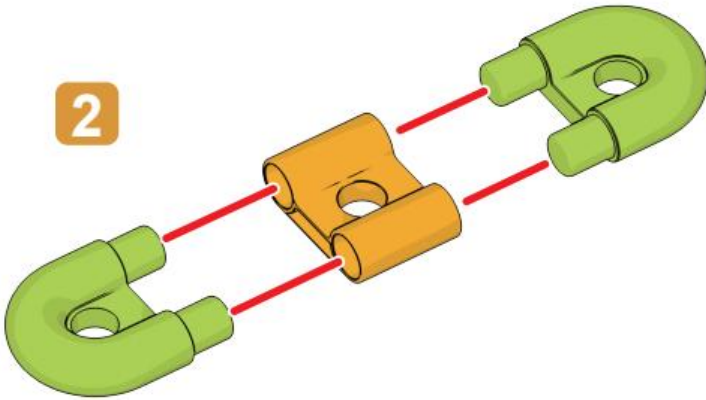

完成
Done

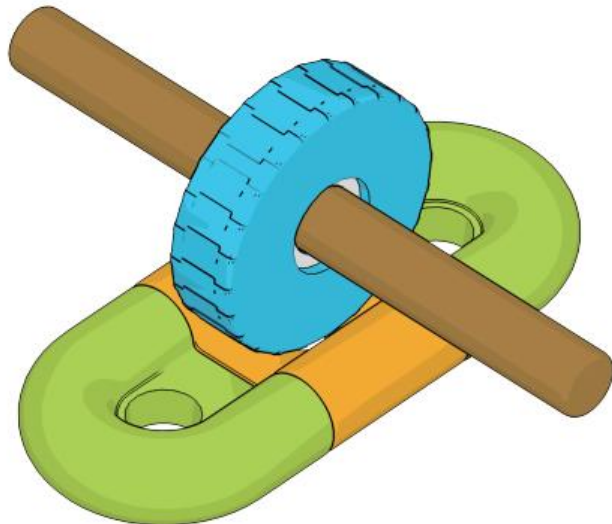



1

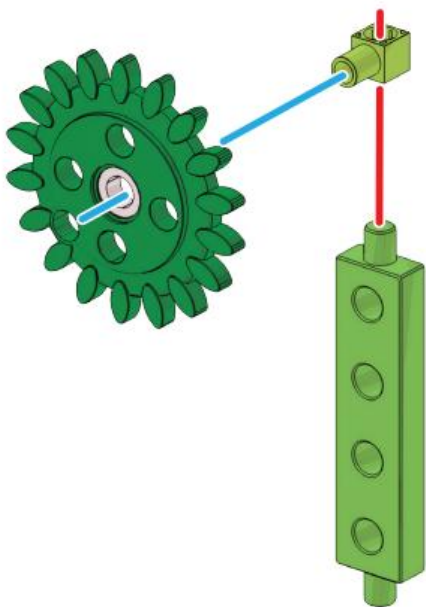

2

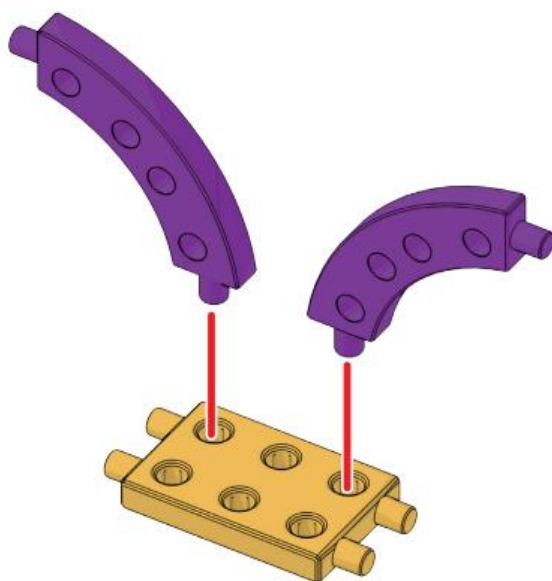



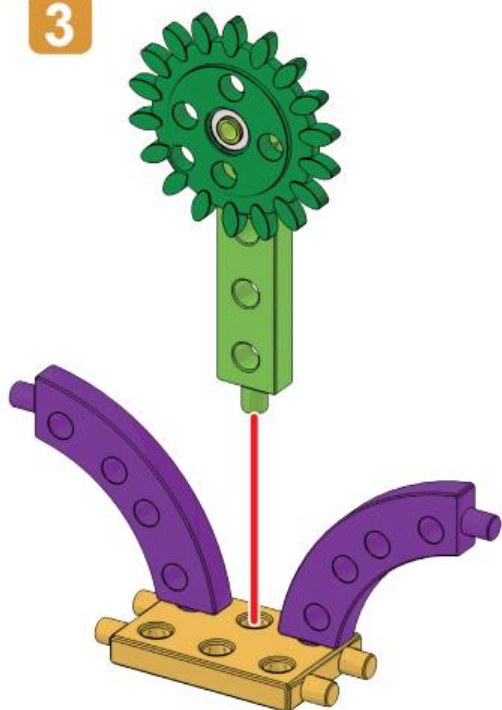

3

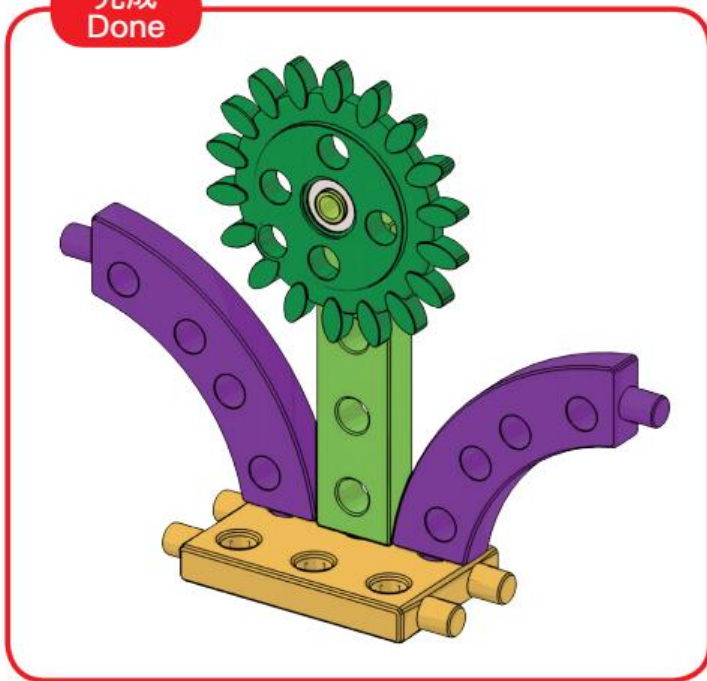

完成 Done



				
4	9	15	16	18
x3	x2	x1	x1	x1

1

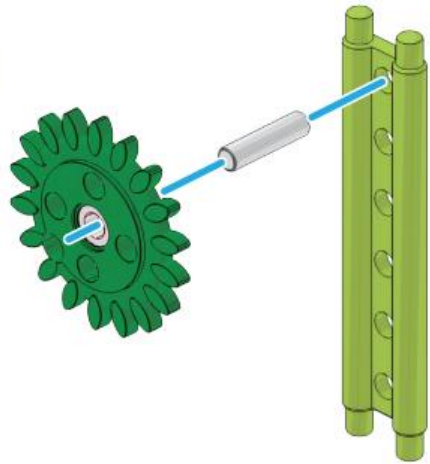

2

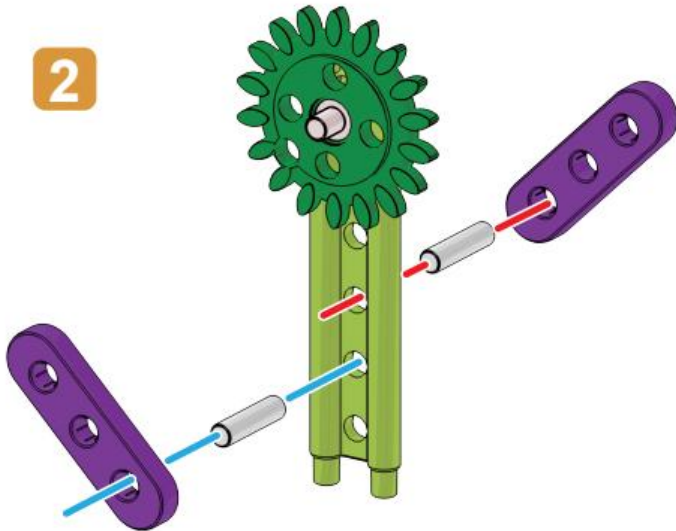

3

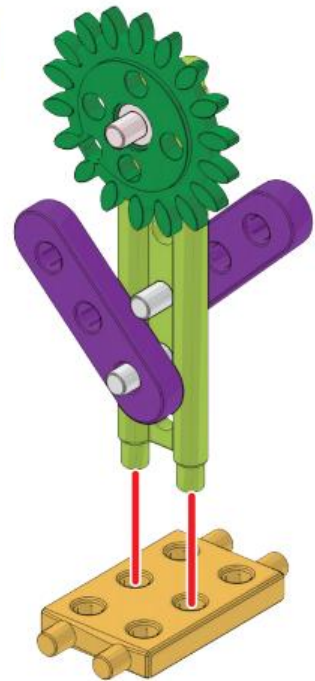

完成
Done

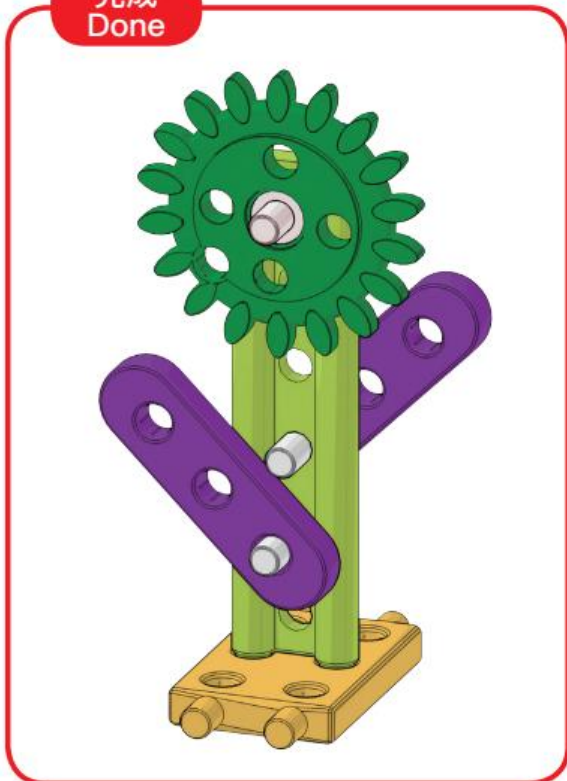

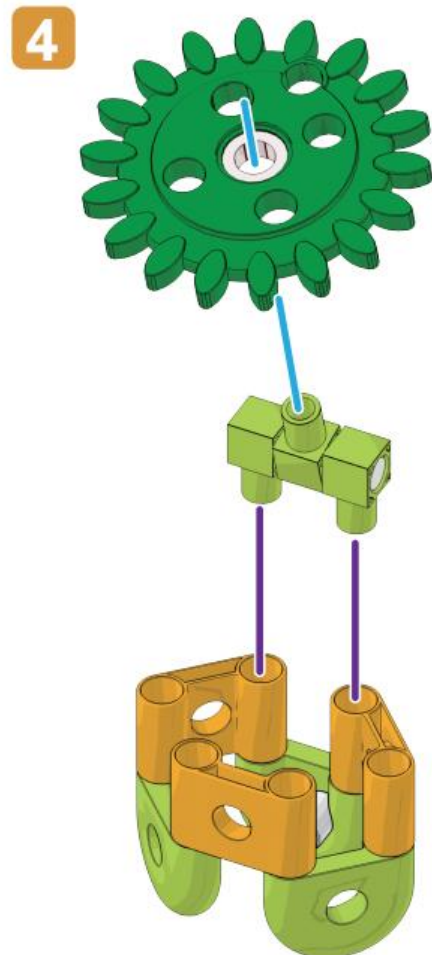
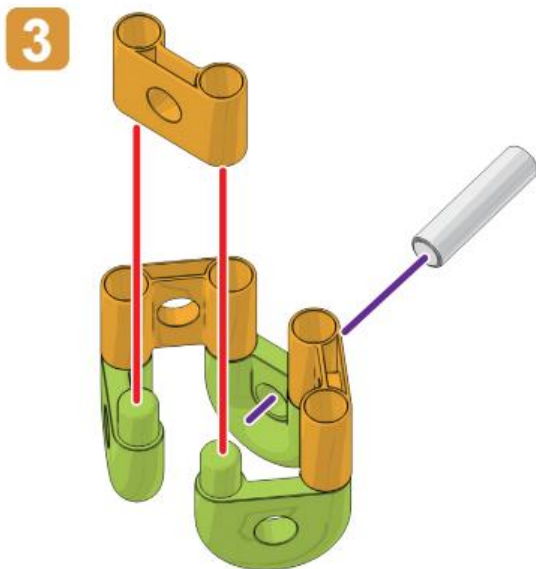
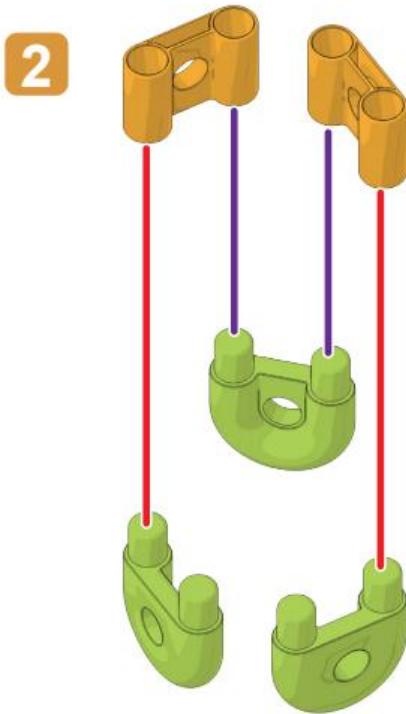
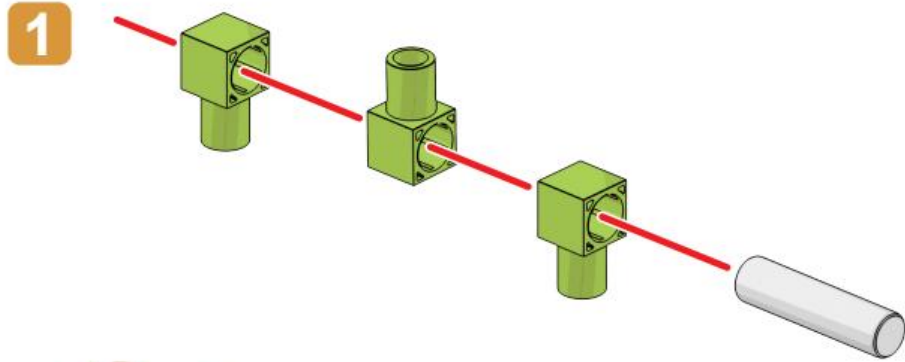
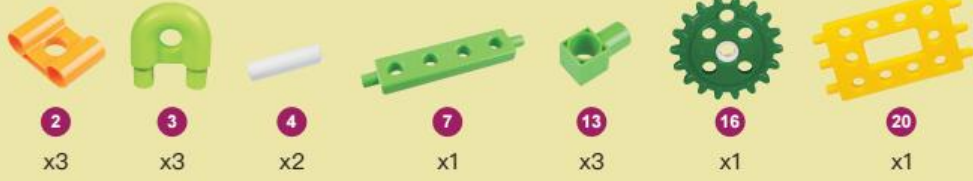

5

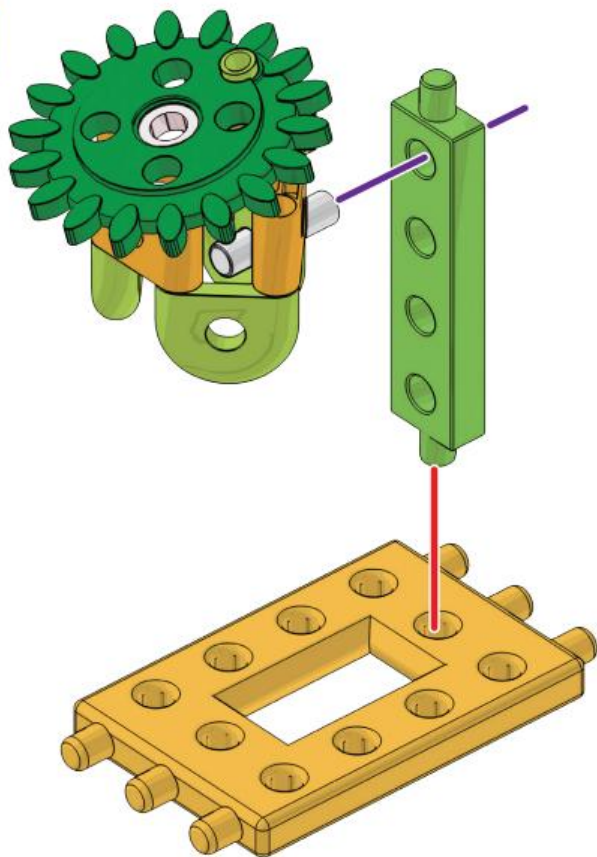

完成
Done

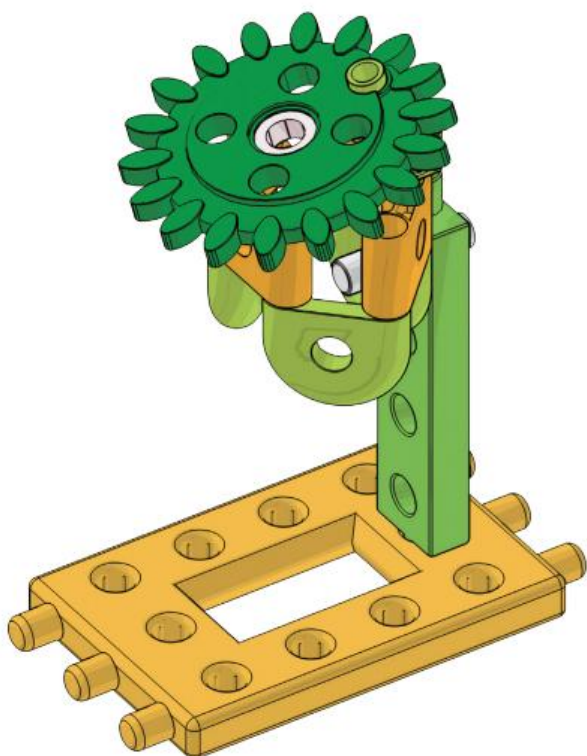



2
x4



18
x1



19
x2



22
x1

1 x2

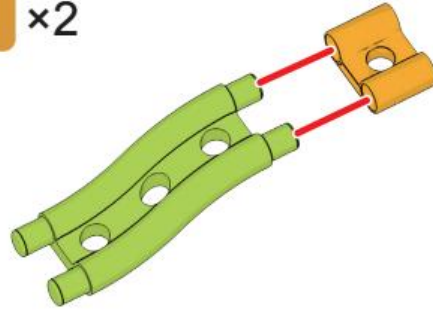

2

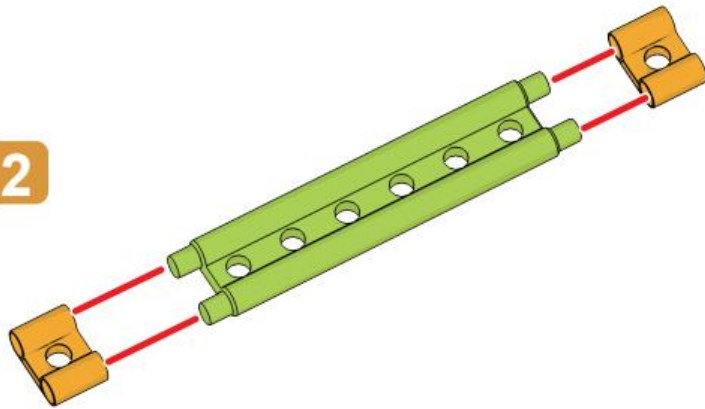

3

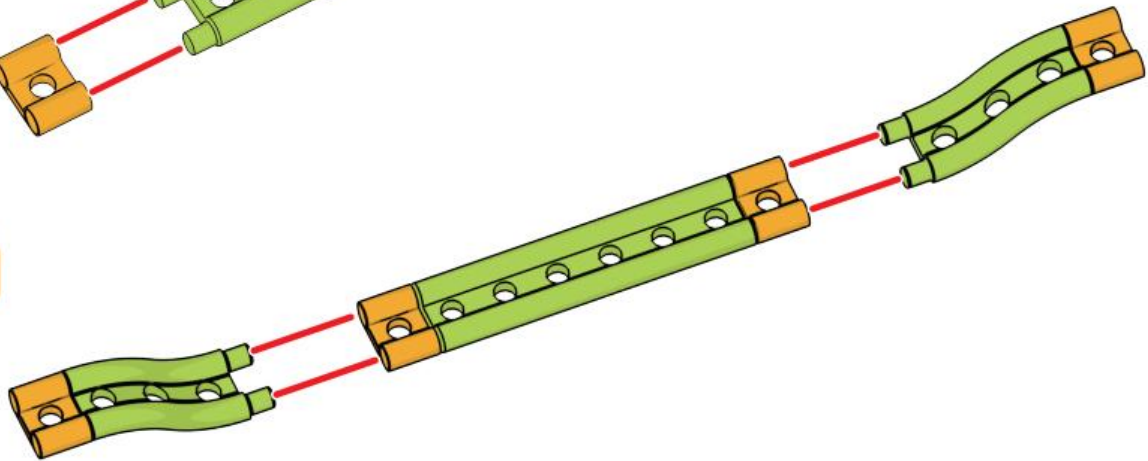

完成
Done

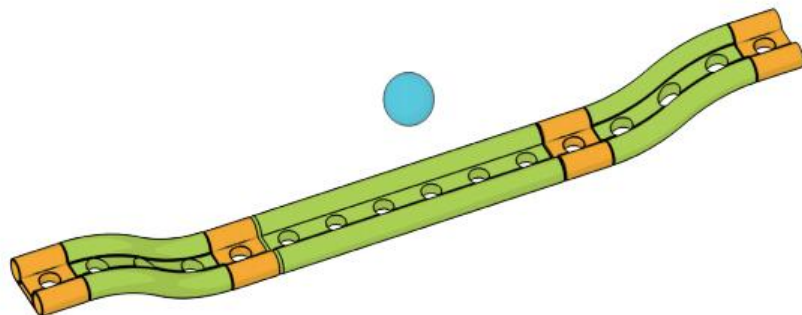

滾球遊戲

Bowling

需用零件 Parts Needed

2	11	13	18	19	22
x4	x2	x2	x1	x1	x1

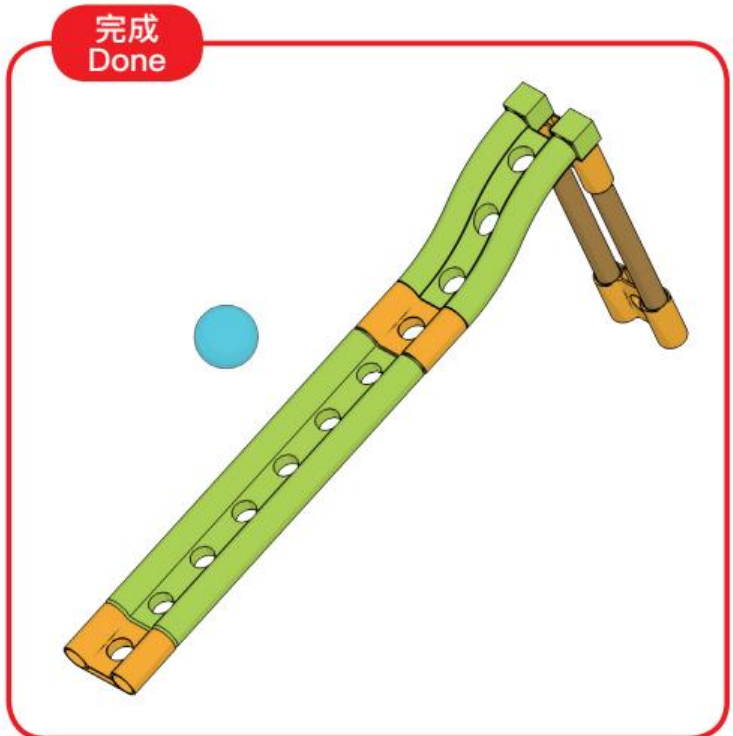
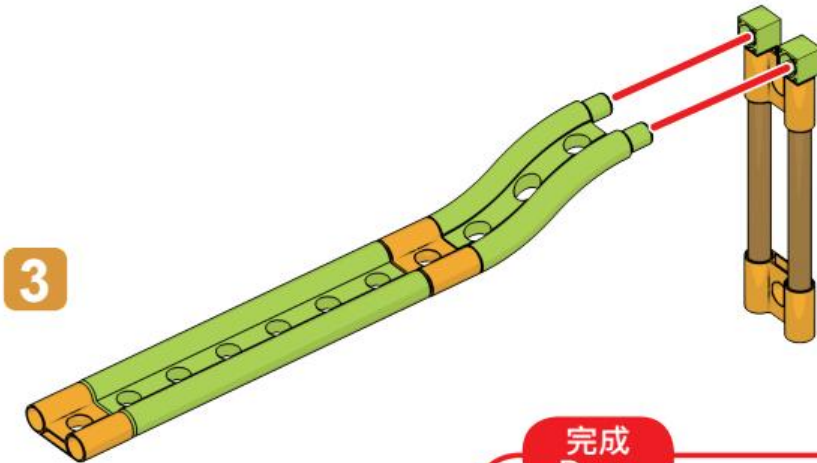
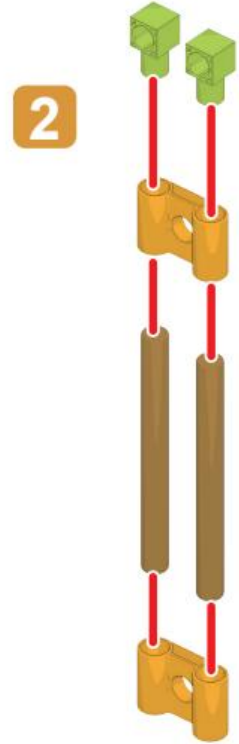
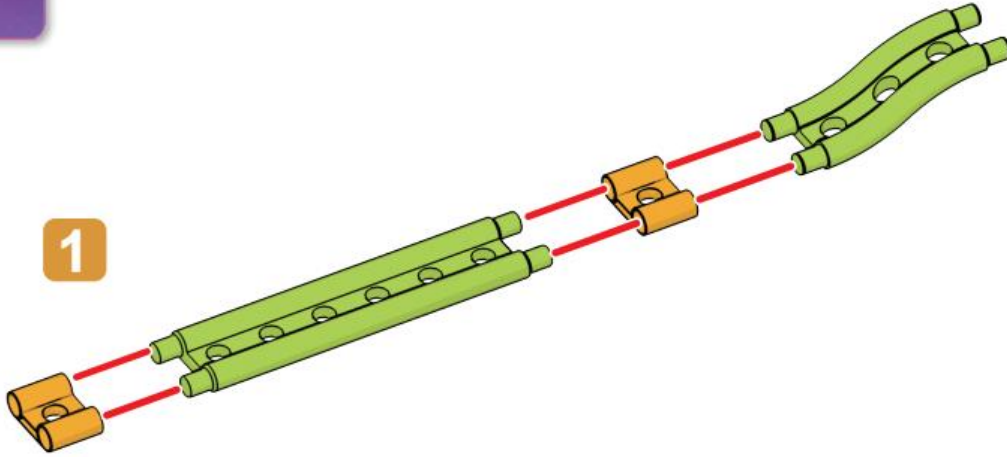



2
x2



3
x1



18
x1



19
x2



22
x1

1

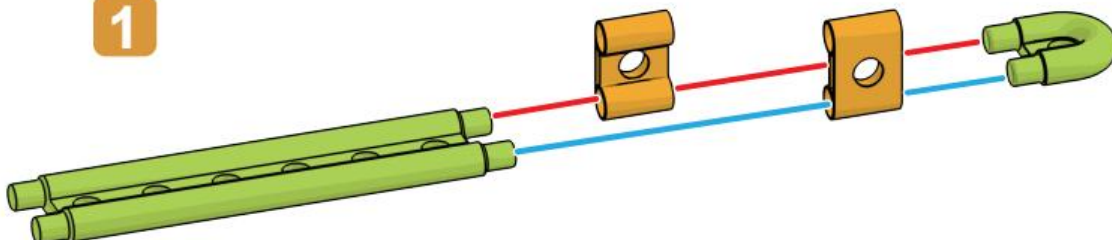

2

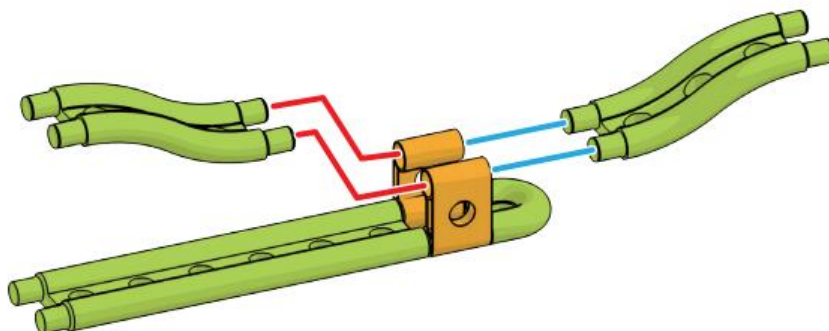

完成
Done

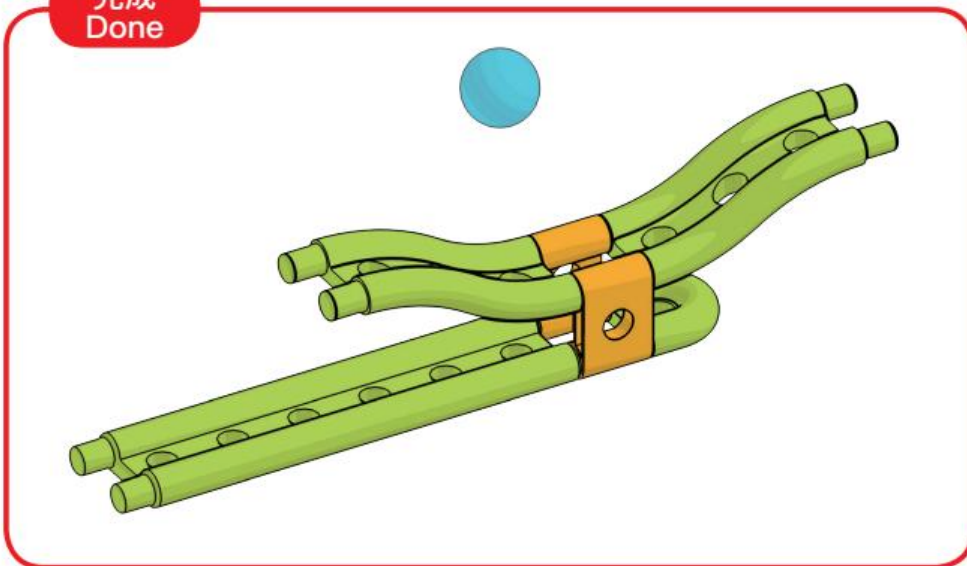

彈球遊戲

Pinball

需用零件 Parts Needed

1	4	7	8	12	17	20	22	23
x2	x1	x2	x1	x2	x4	x1	x1	x1

1

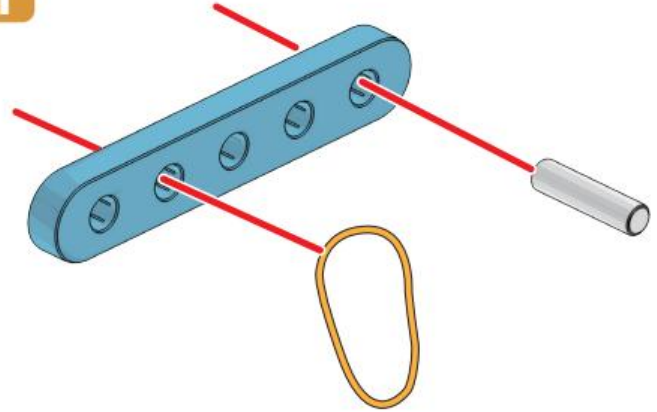

2

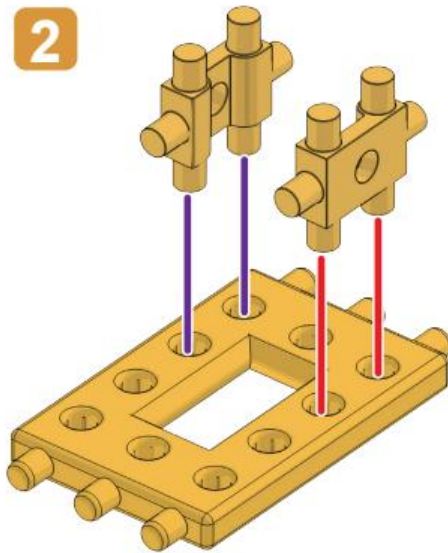

3

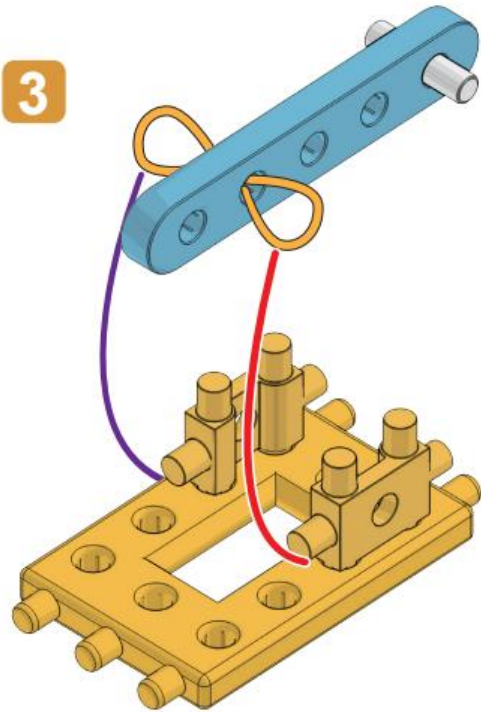

4

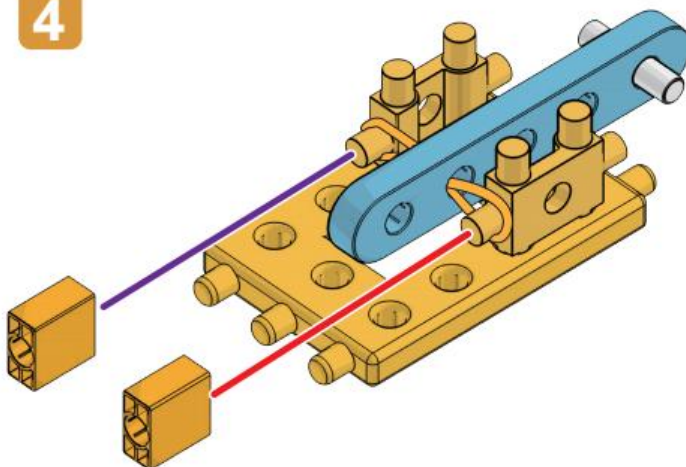

5 x2

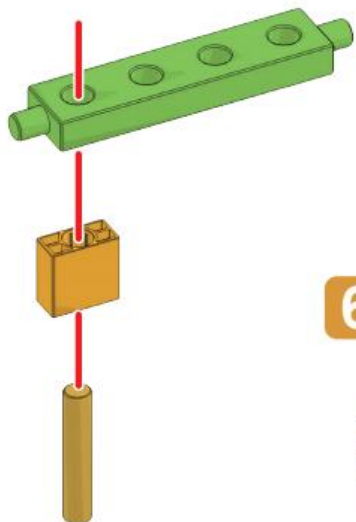

6

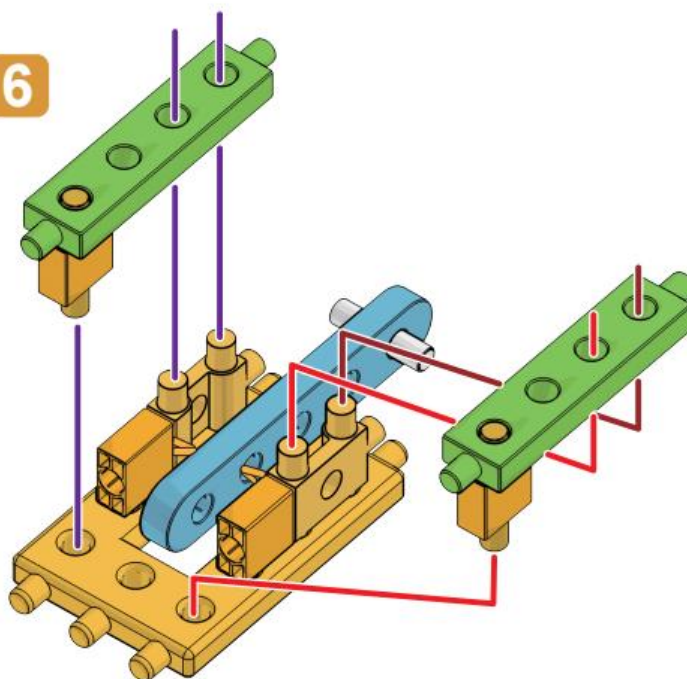



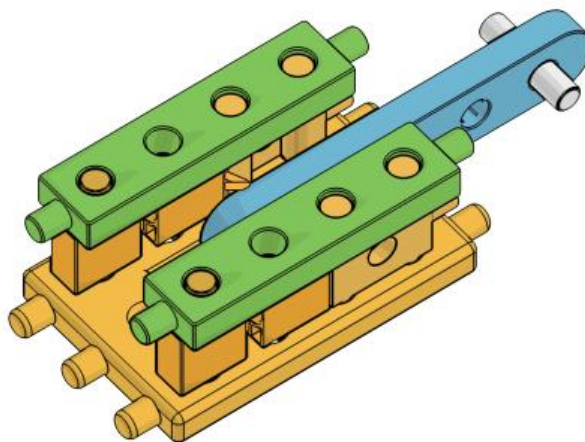







完成
Done



拋接遊戲

Throw and Catch

需用零件 Parts Needed

							
1	2	3	8	11	13	14	17
x2	x3	x3	x2	x1	x2	x2	x2
							
18	21	22					
x1	x4	x1					

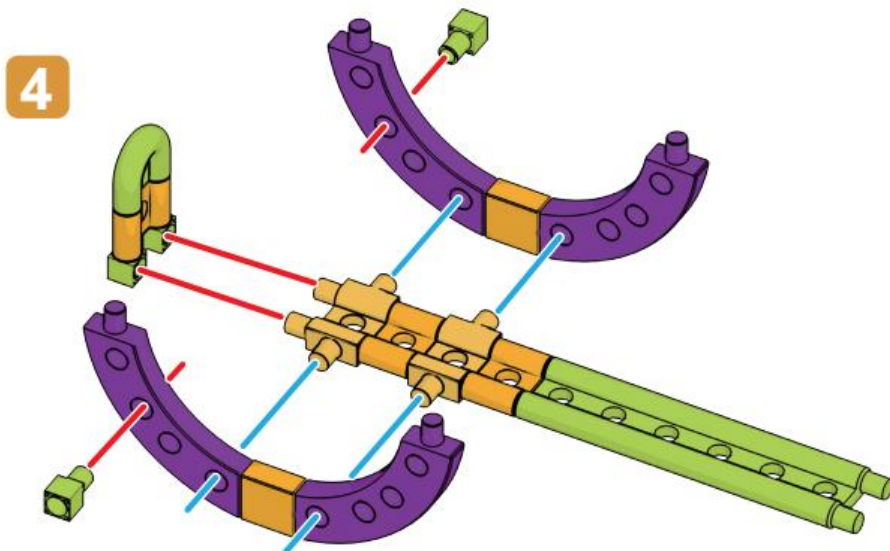
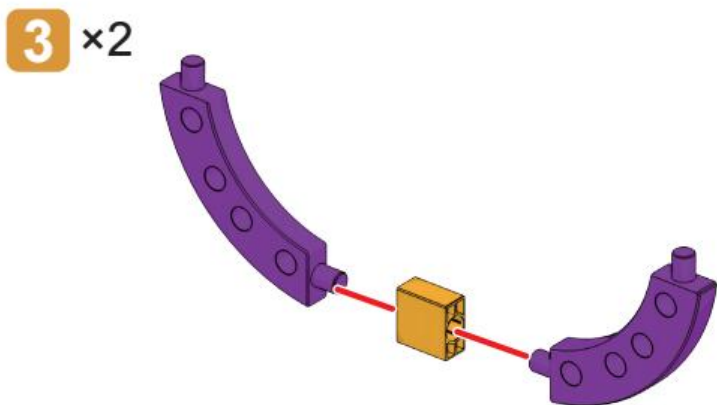
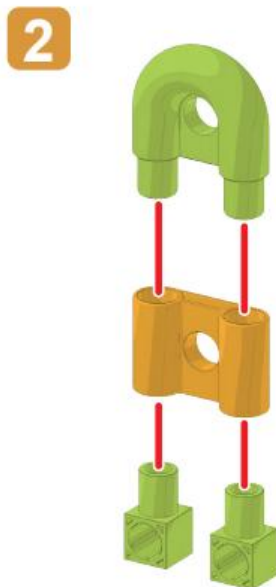
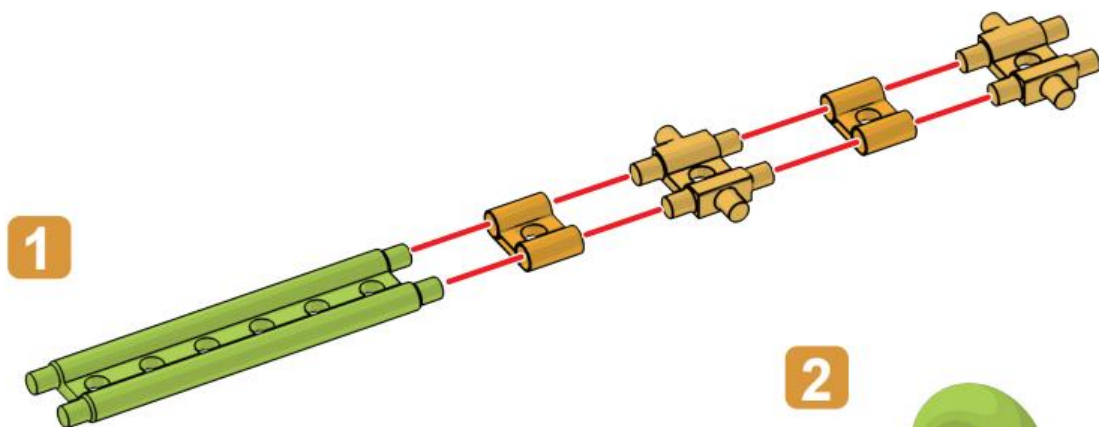

5

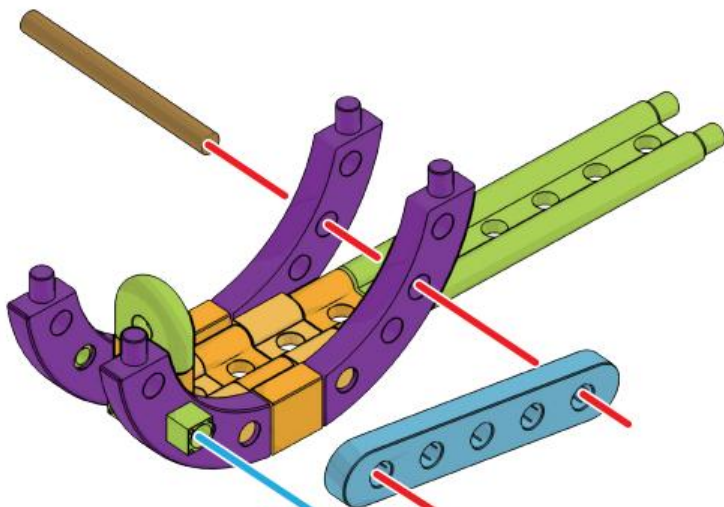

6

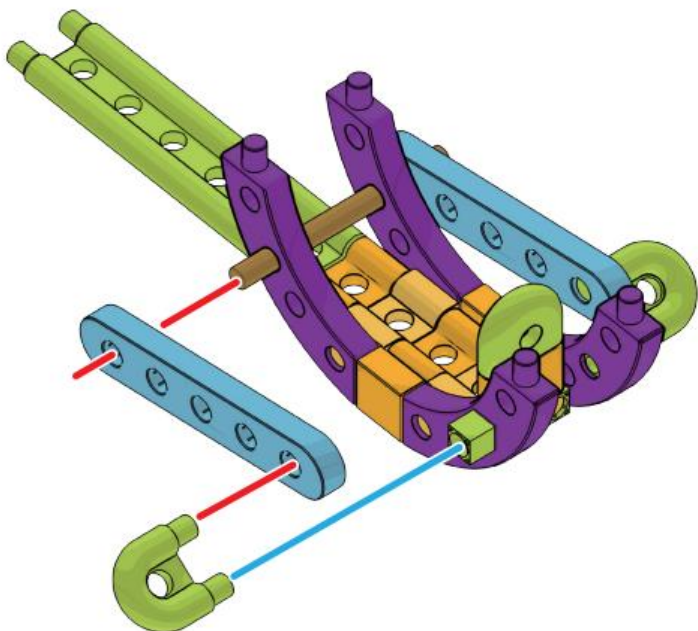

完成
Done

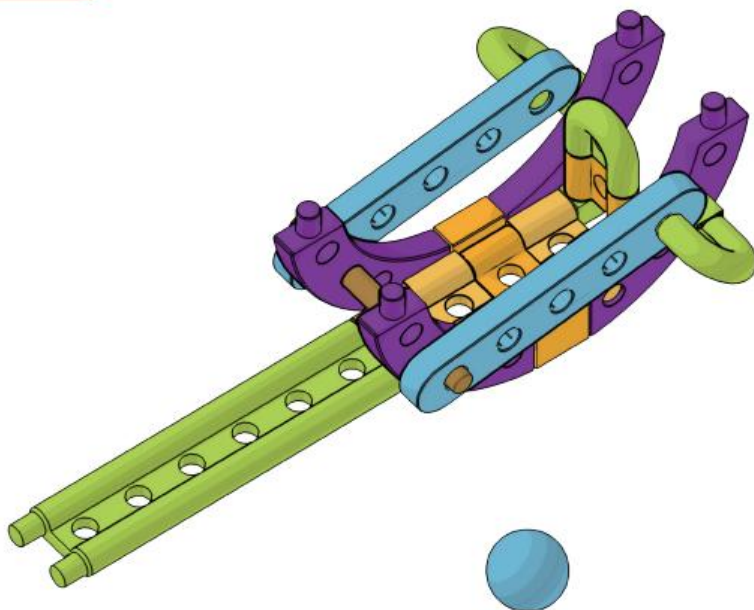

刮胡

Güiro

需用零件 Parts Needed





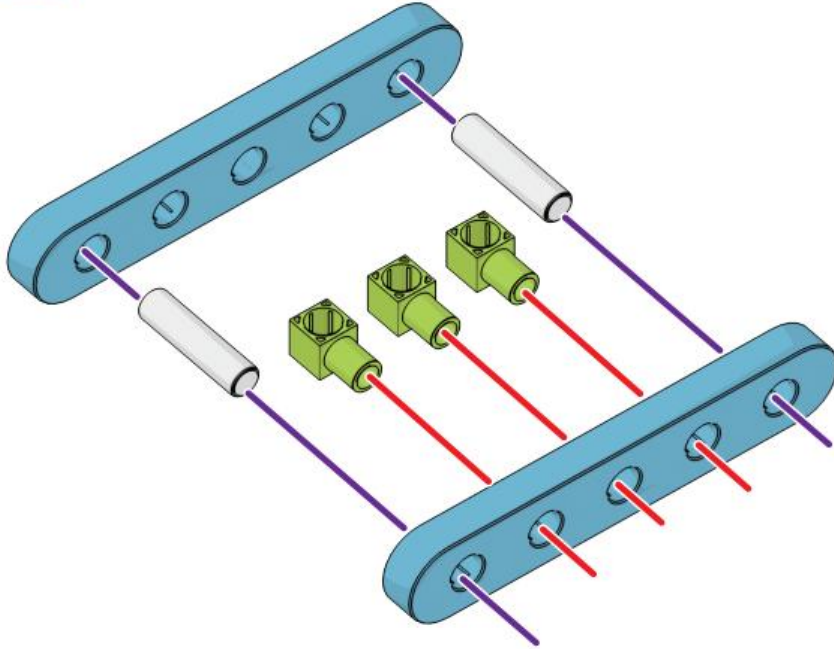

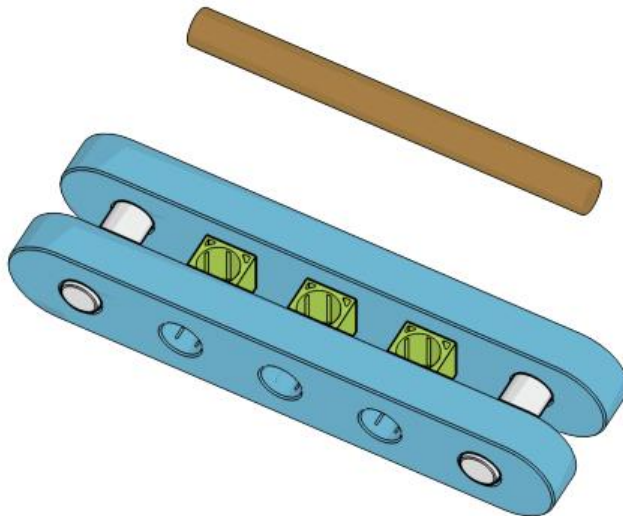

			
4	8	11	13
x2	x2	x1	x3

1



完成
Done



							
2	3	4	6	10	13	15	17
x2	x2	x3	x1	x1	x3	x1	x1

1

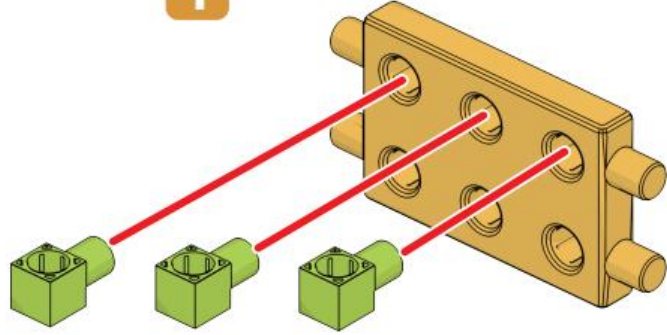

2

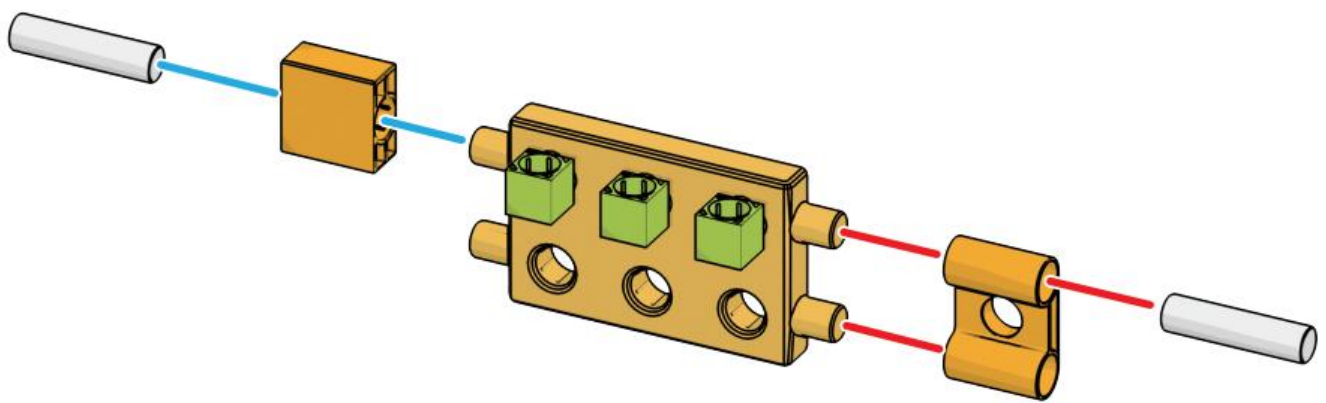

3

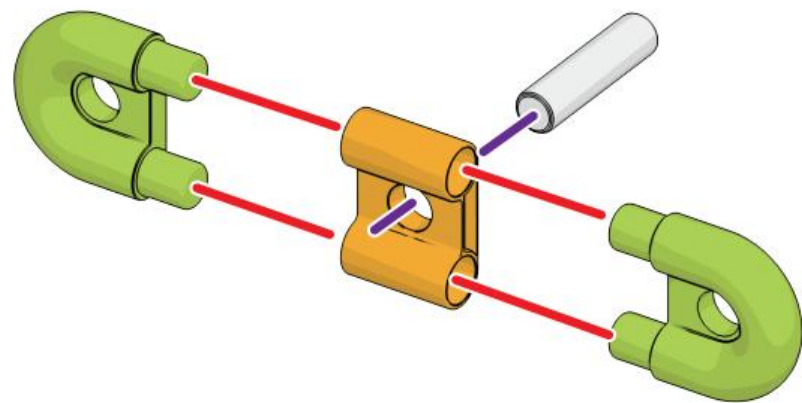

4

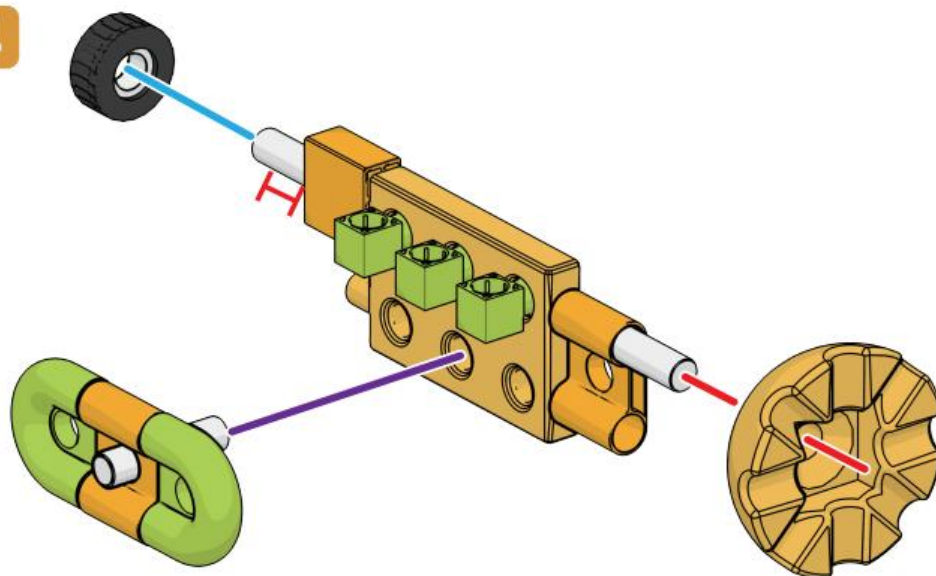

完成
Done

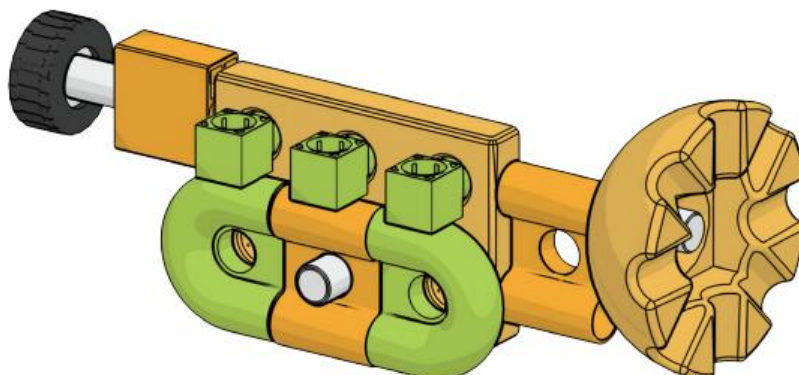

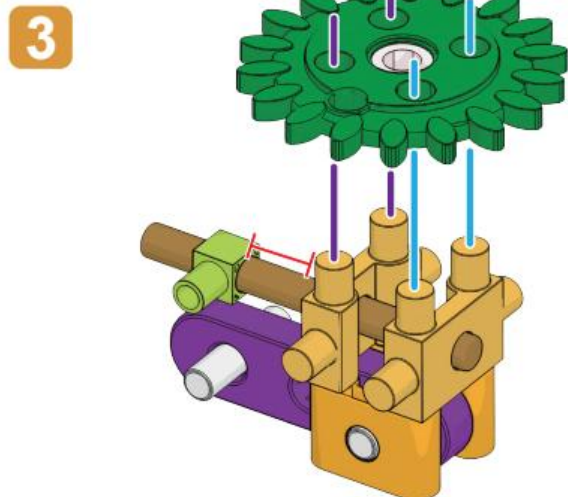
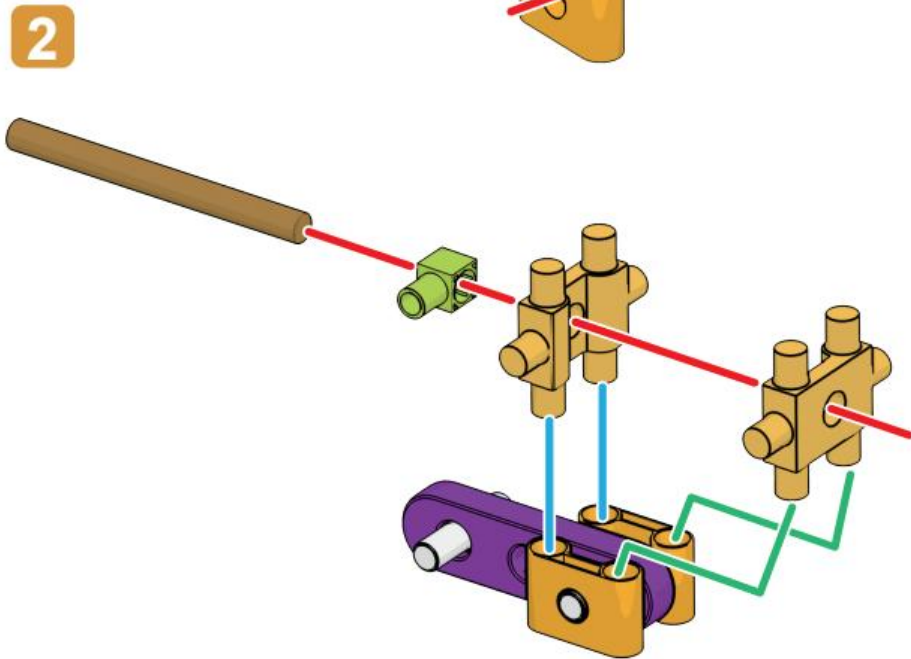
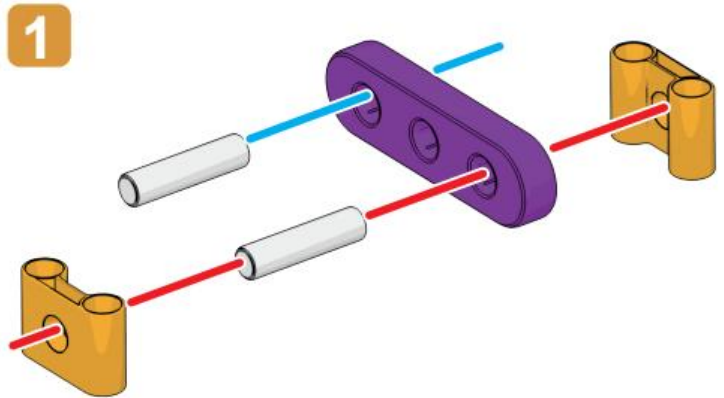
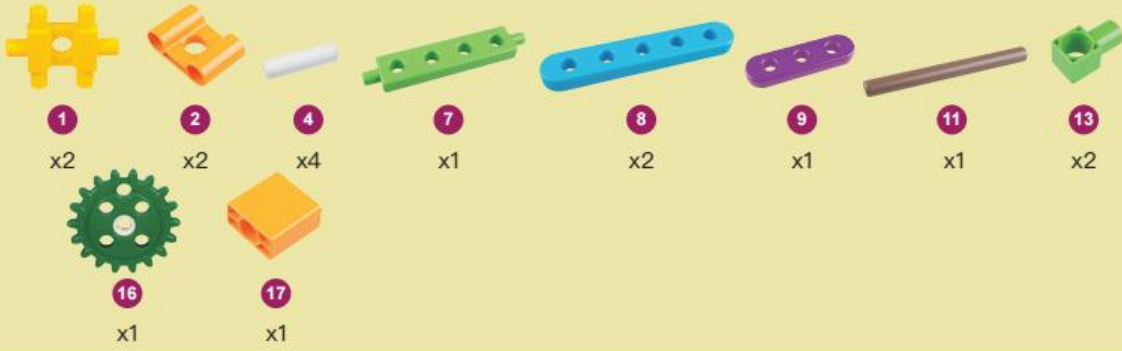

4

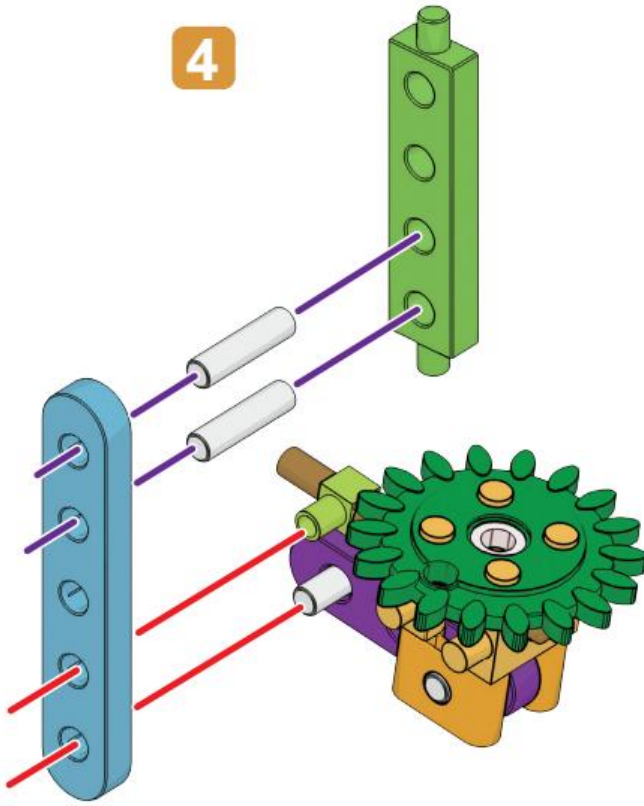



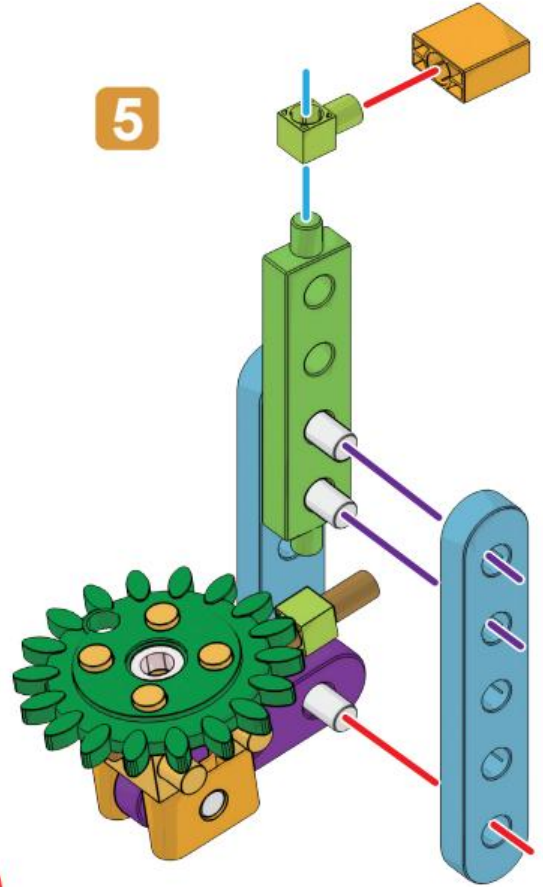



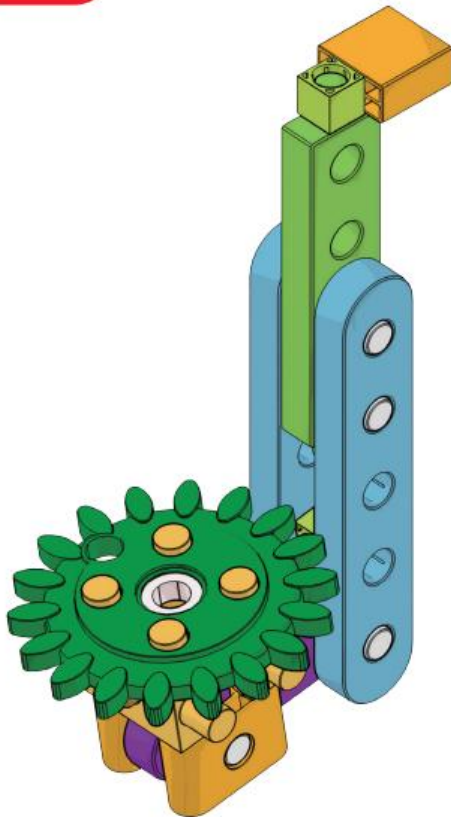





5



完成
Done



							
4	5	6	7	8	9	10	11
x4	x1	x1	x2	x1	x1	x1	x2
							
12	13	14	16				
x2	x1	x1	x1				

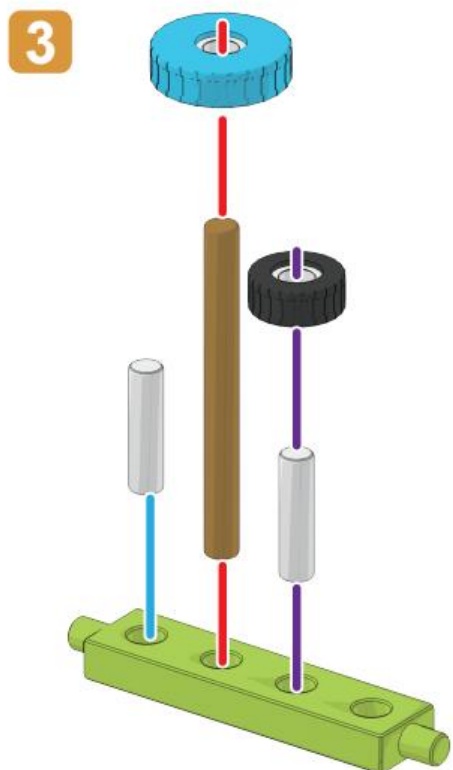
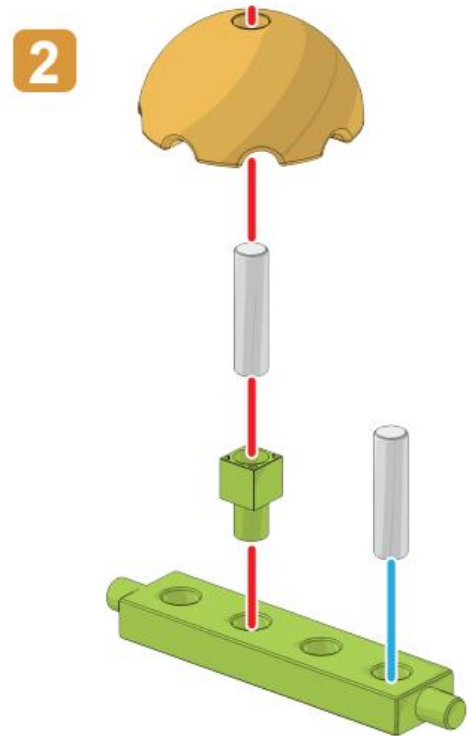
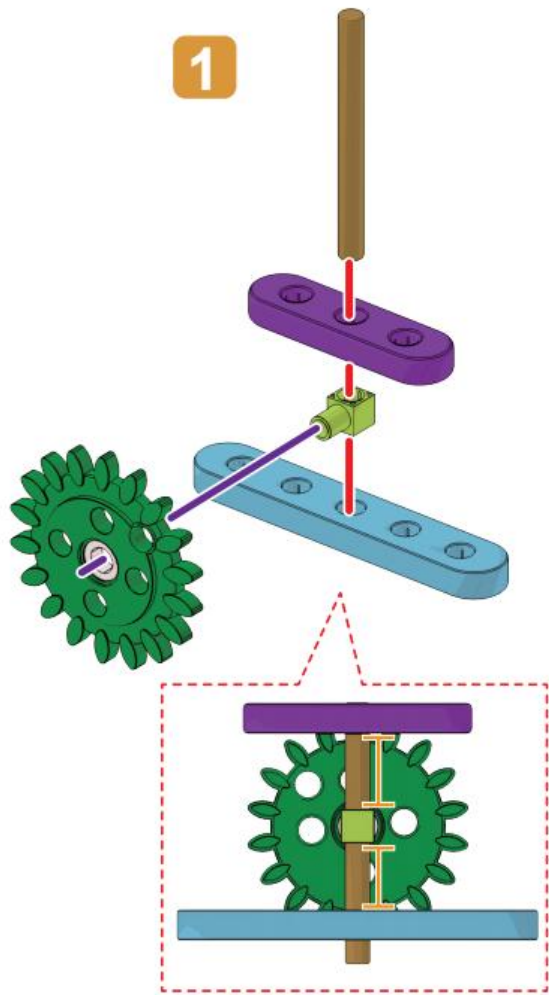

4

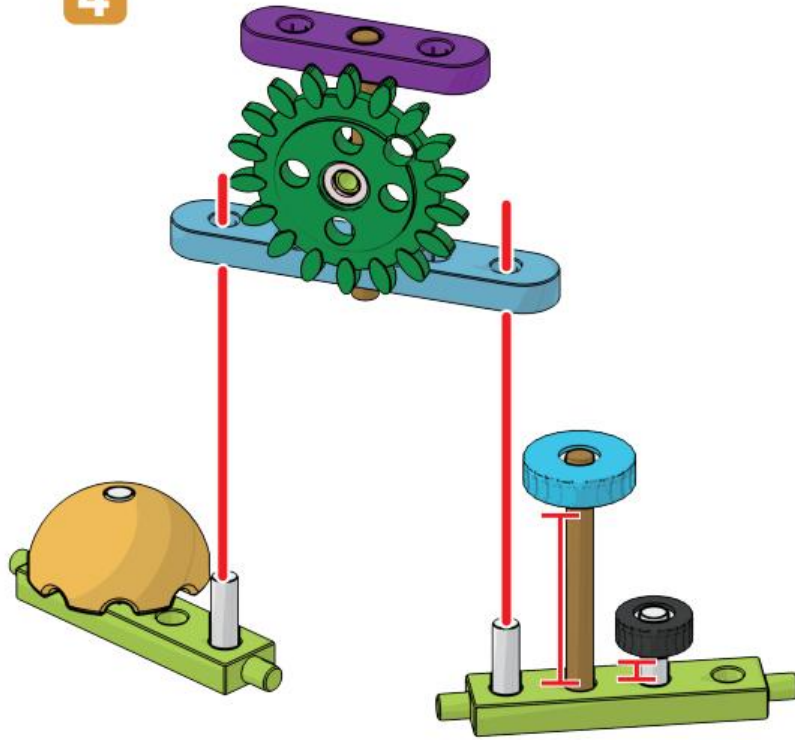

完成
Done

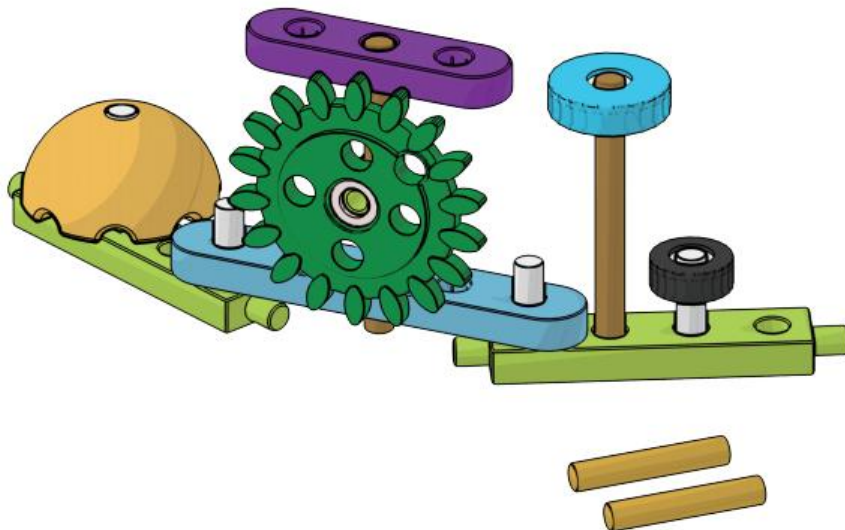



1
x2



2
x1



4
x1



6
x1



9
x2



14
x1



15
x1



17
x2



18
x1



23
x1

1

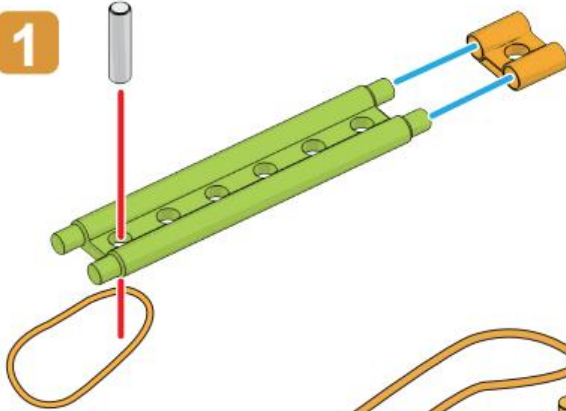

2

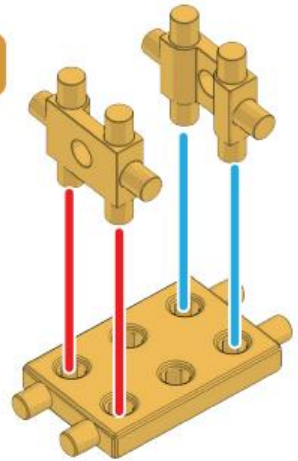

3

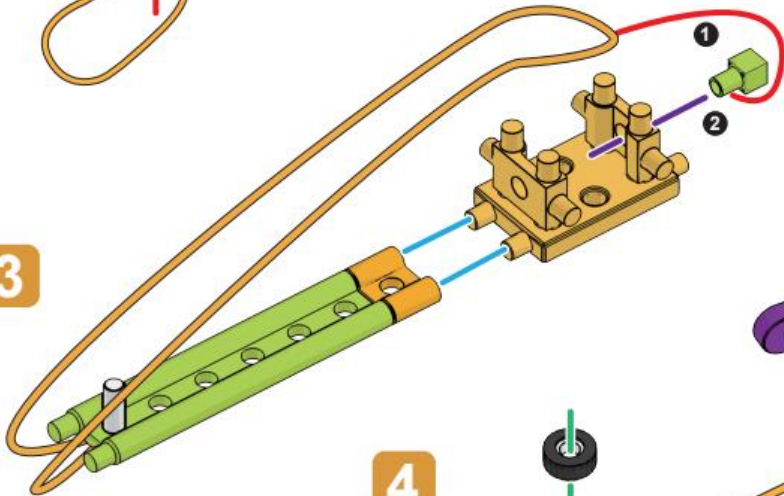

4

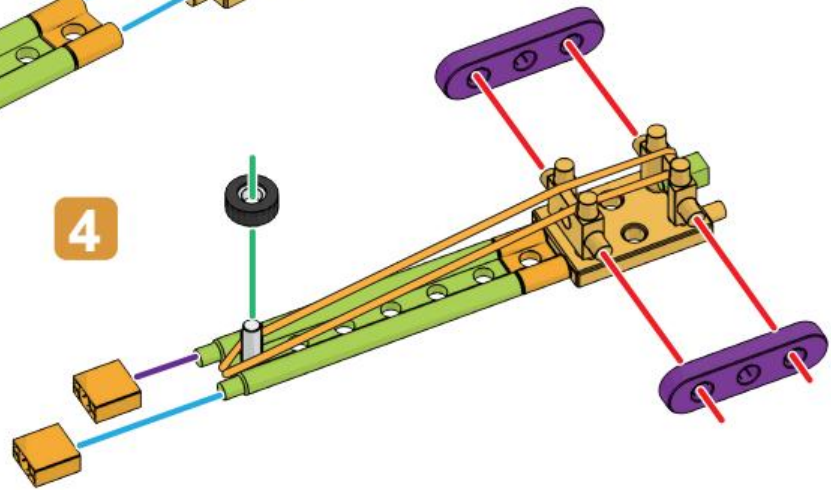



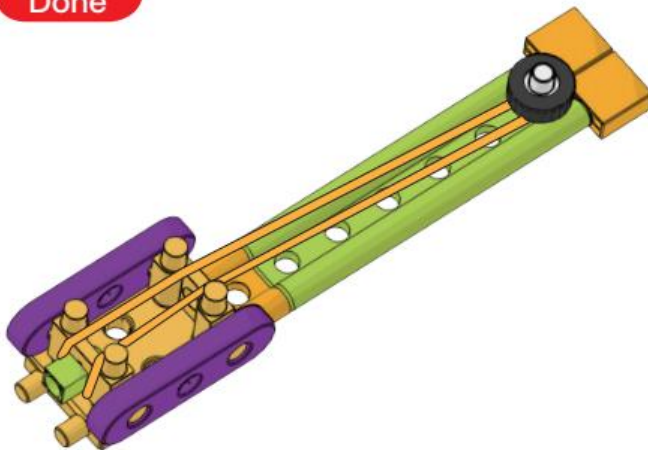





完成
Done



足球

Football

需用零件 Parts Needed

							
4	8	9	12	14	17	18	22
x2	x1	x2	x2	x2	x2	x1	x1

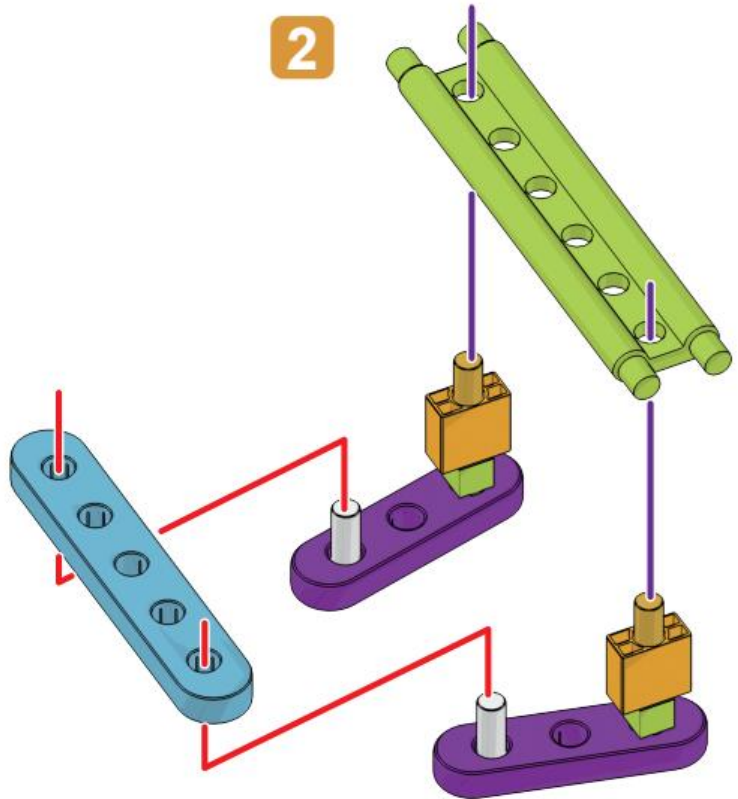
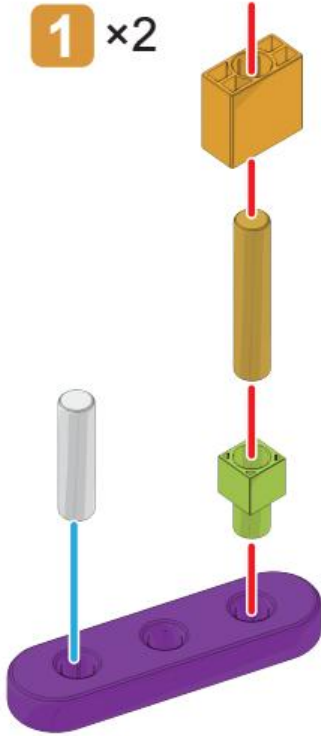



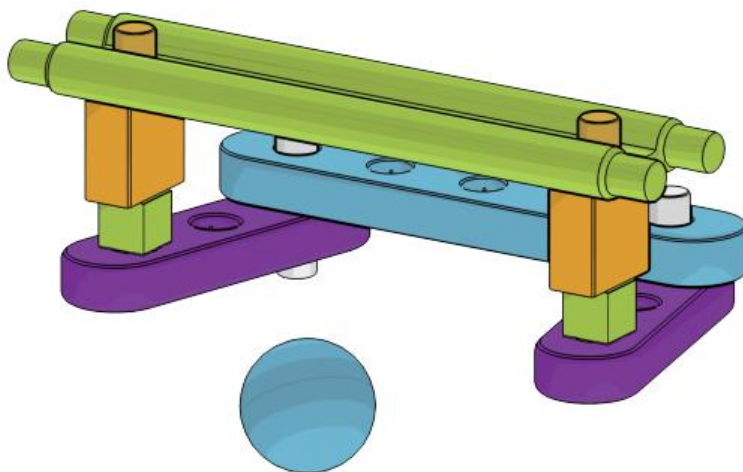

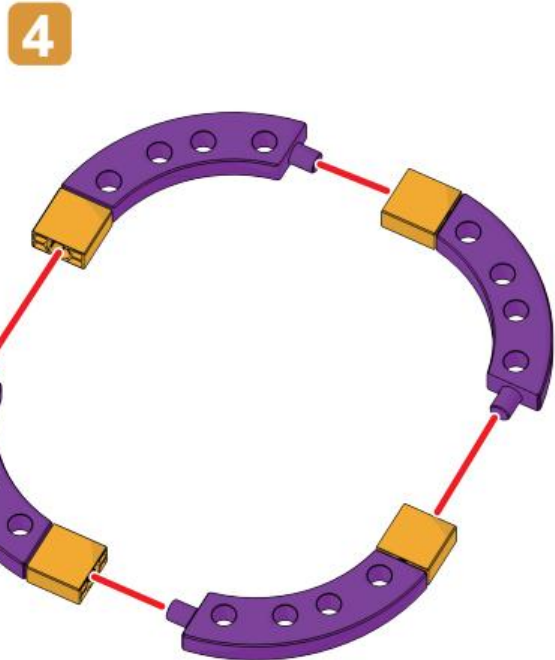
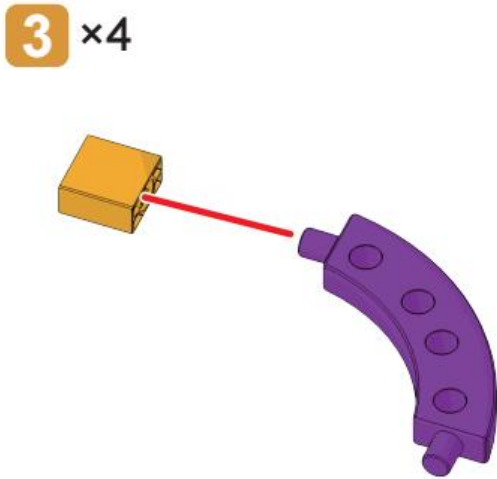
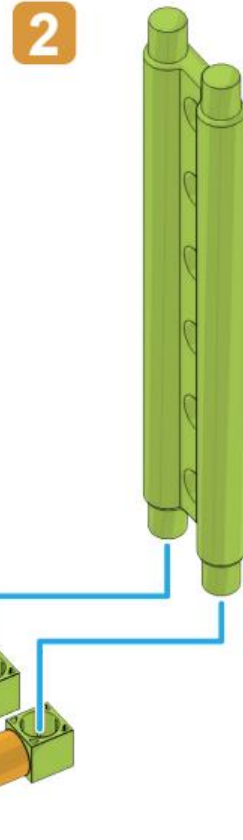
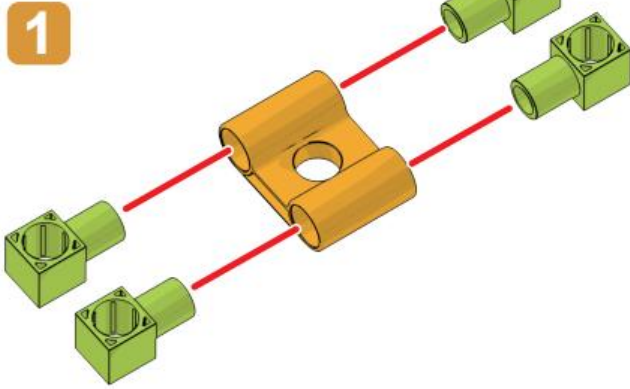

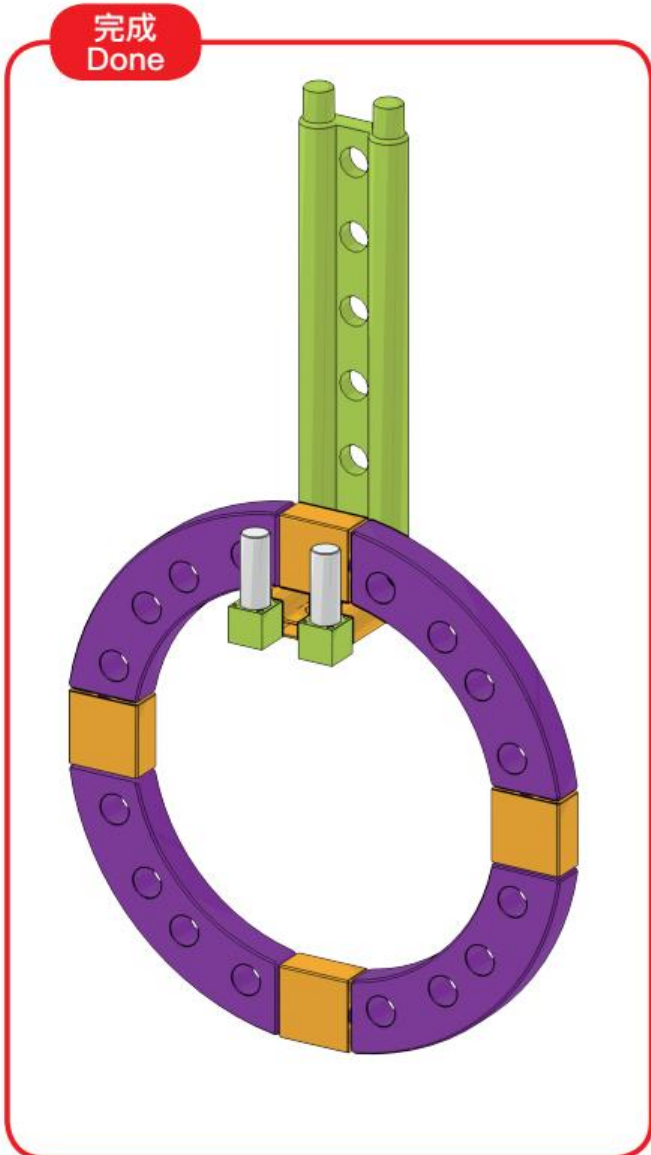
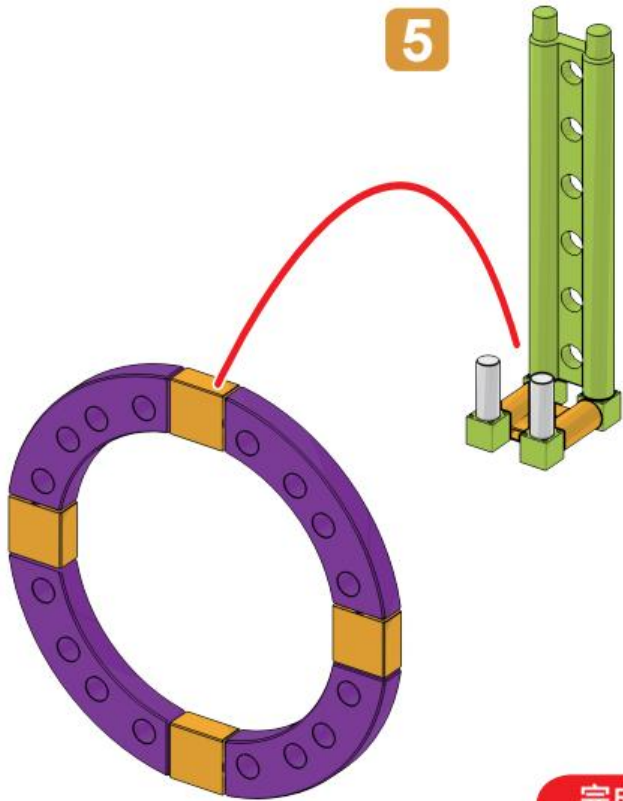

完成
Done









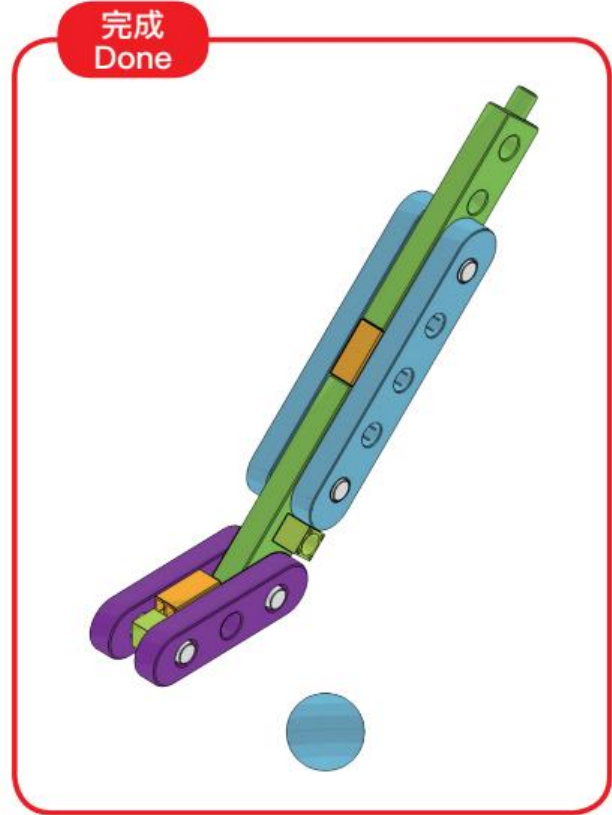
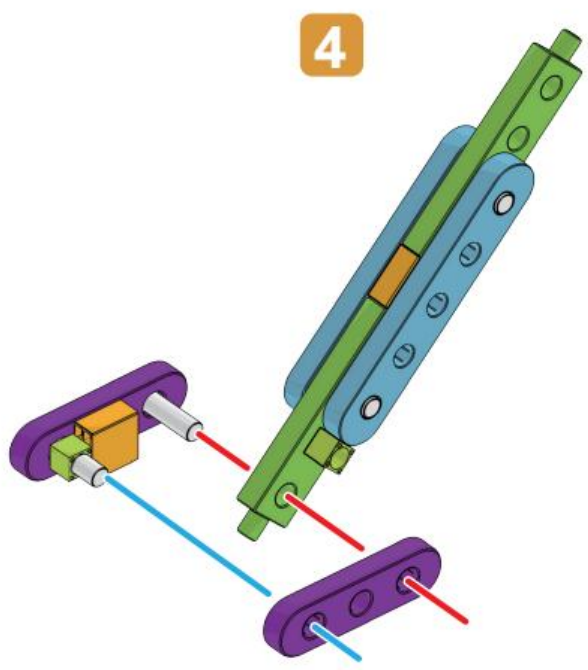
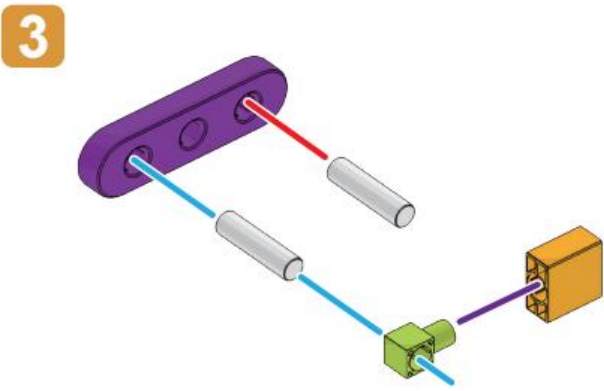
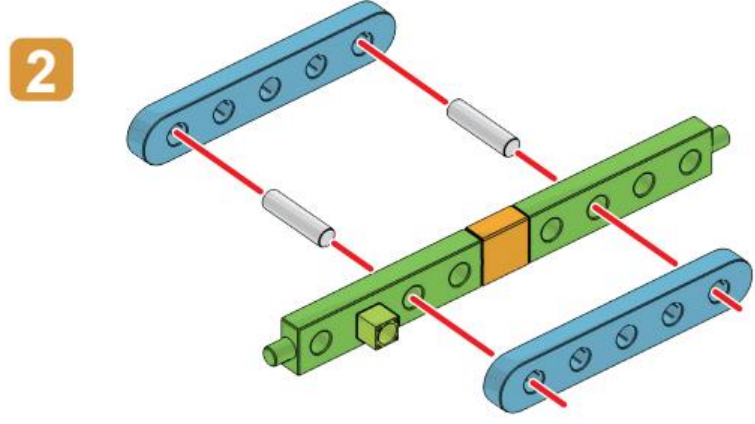
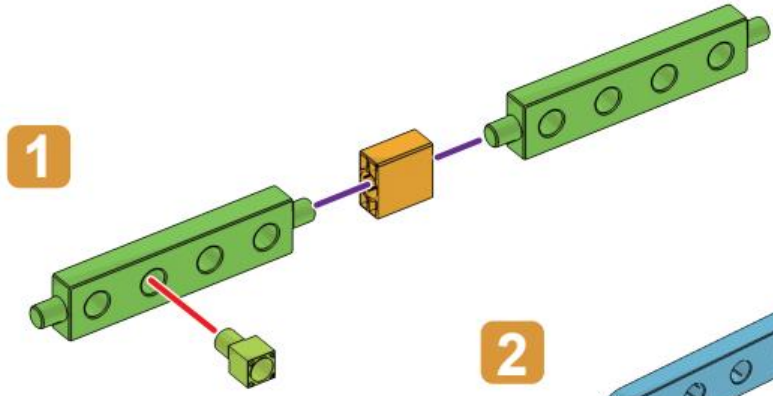





							
4	7	8	9	13	14	17	22
x4	x2	x2	x2	x1	x1	x2	x1



籃球

Basketball

需用零件 Parts Needed

							
2	3	4	13	15	18	20	22
x5	x4	x2	x2	x1	x1	x1	x1

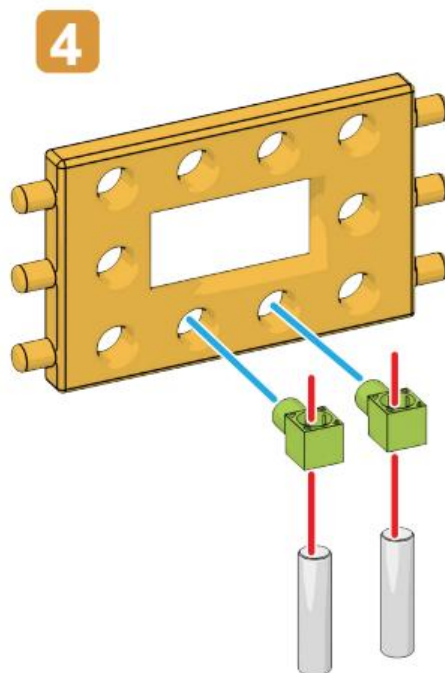
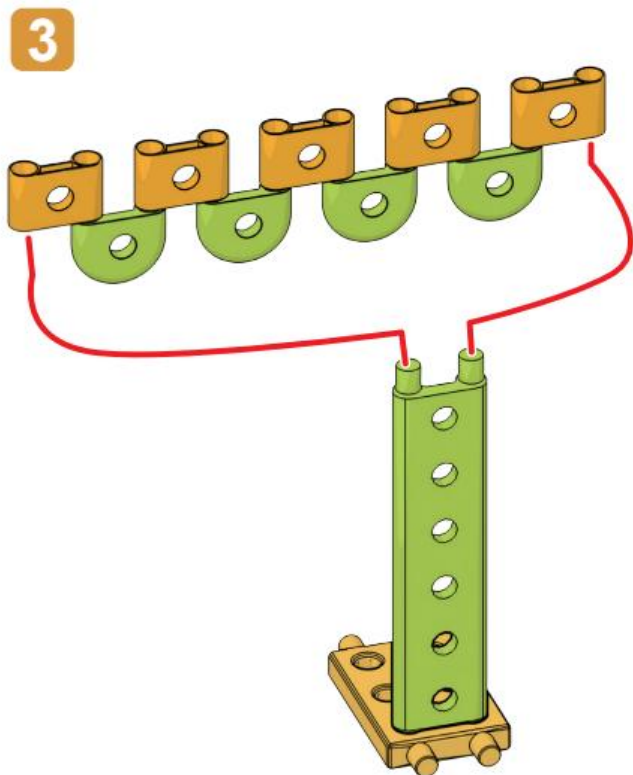
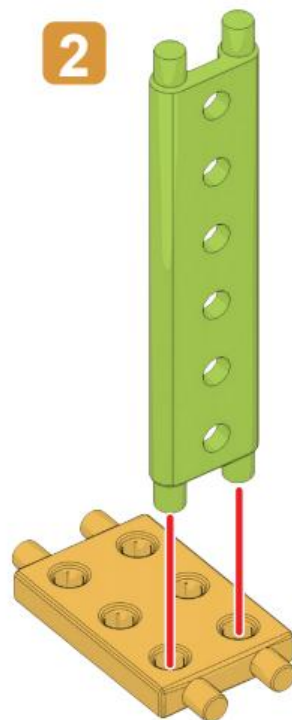
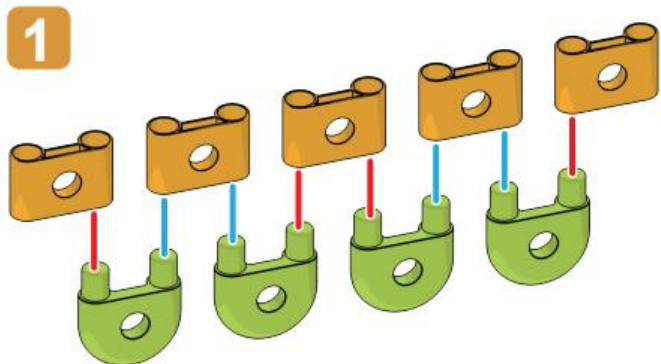

5

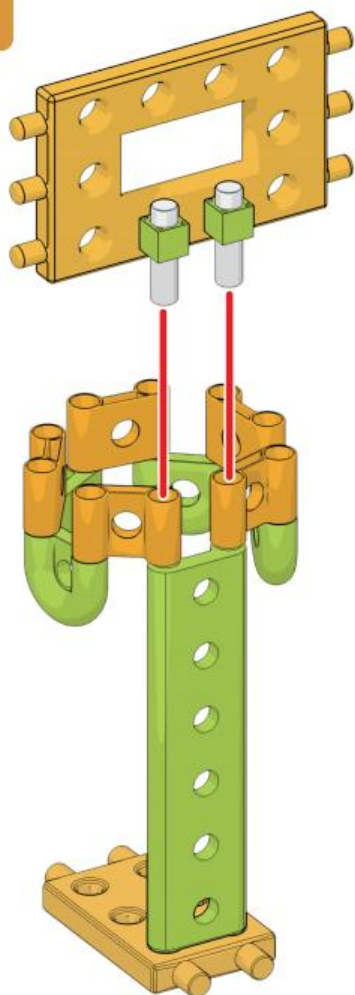

完成
Done

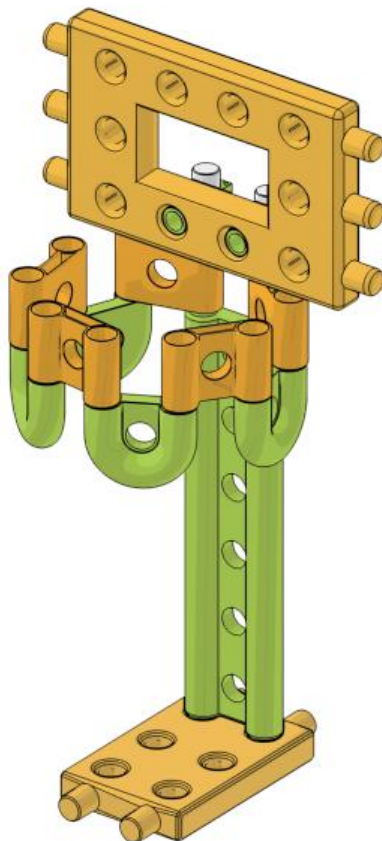

弓箭

Bow and Arrow

需用零件 Parts Needed

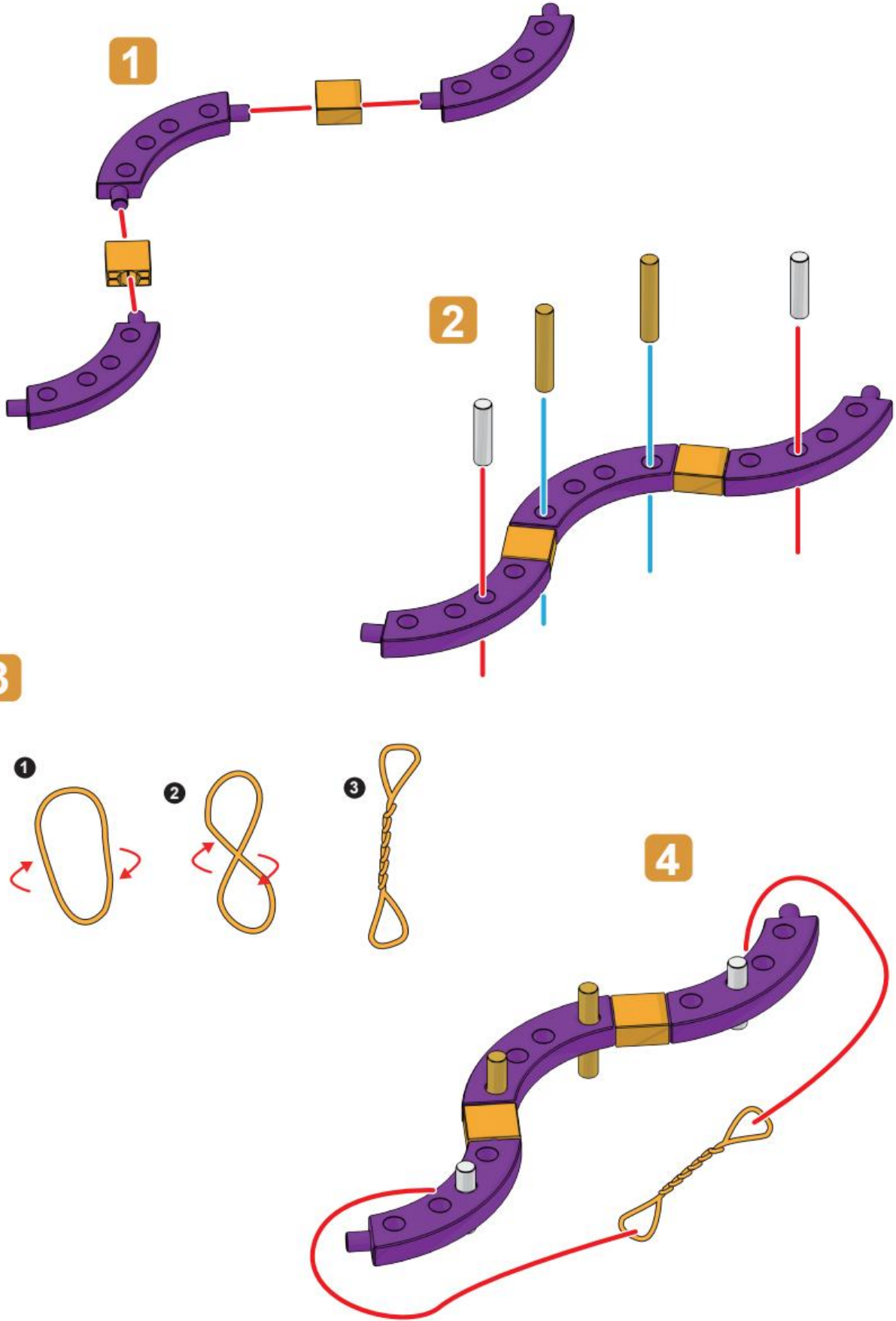
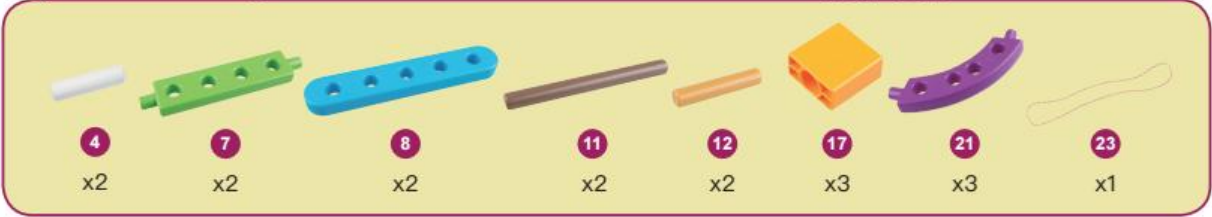

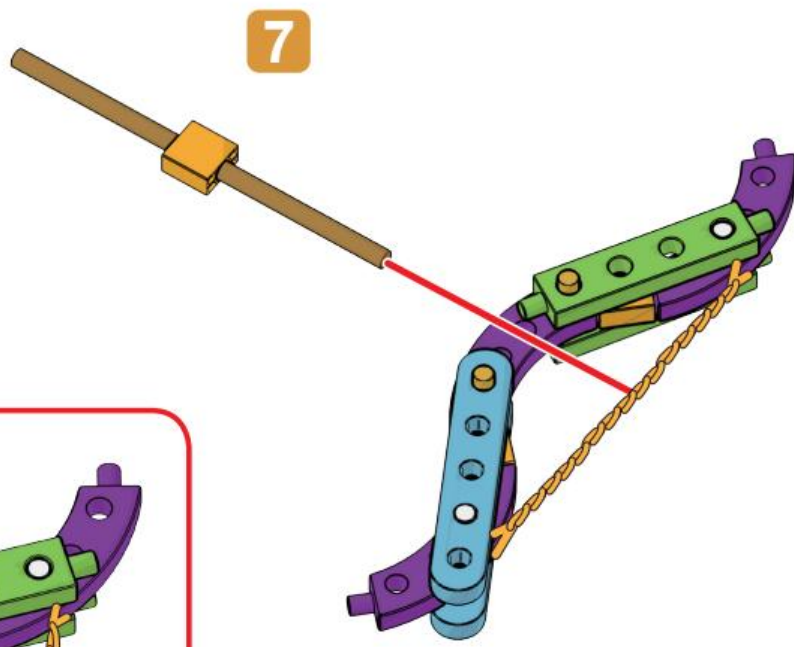
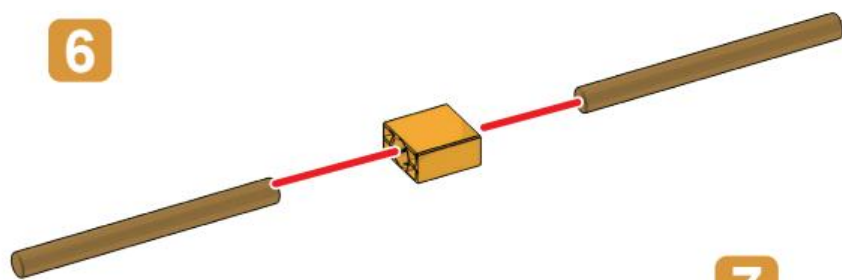
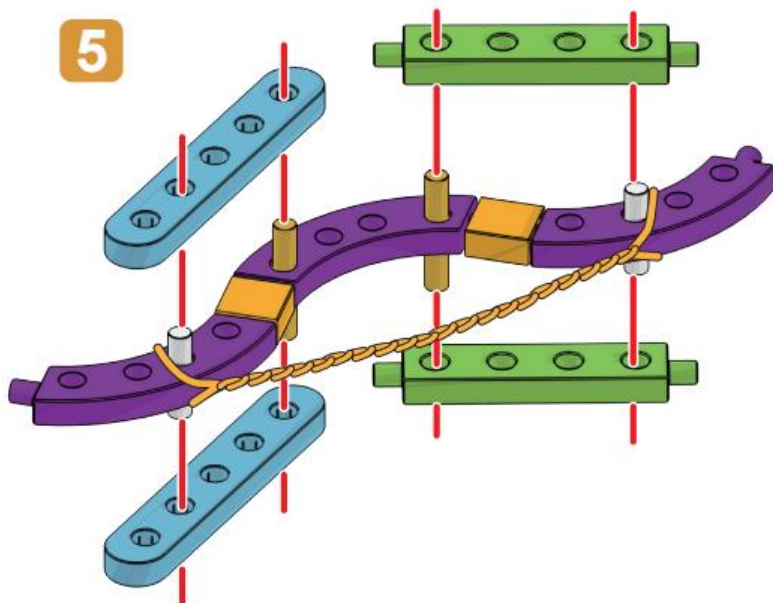

完成
Done

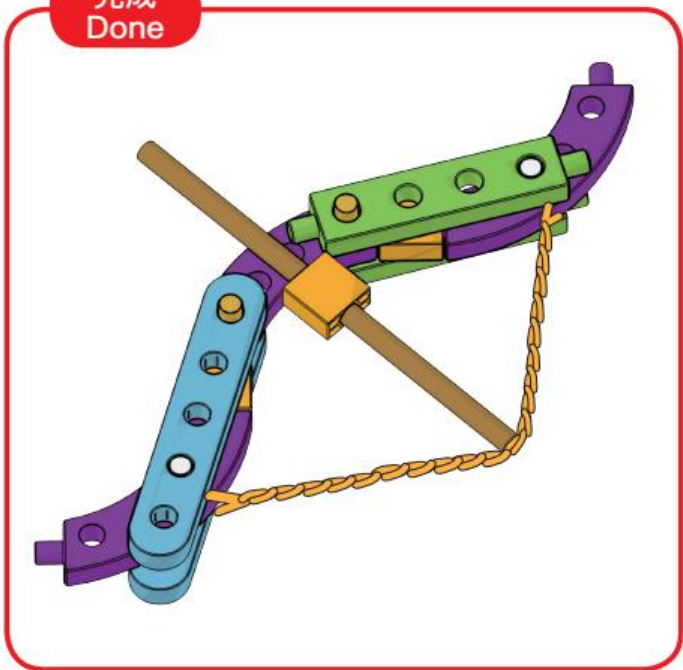

FUN LAB



#1260
創意積木組
CREATIVE CUBE



#1261
科學探索組
SCIENTIFIC TOUR



#1270
趣味機關組
FUN WITH MECHANISM



#1262
電學補充包
ELECTRICITY KIT



#1264
氣動補充包
PNEUMATICS KIT



#1265
風力補充包
WIND POWER KIT



#1266
水力補充包
HYDRAULICS KIT



#1267
太陽能補充包
SOLAR POWER KIT



MADE IN TAIWAN

GENIUS TOY TAIWAN CO., LTD.
www.gigotoys.com

© 2017 Genius Toy Taiwan Co., Ltd. All rights reserved R21#1272